

Product Type: **Thermostat Modular**
 Product Code: **E180183**
 Product Name: **Estetiche per versione termostatica 2 e 3 vie**
2-3 way trim set for thermostat version

Description: estetica termostatica rosoni quadri e maniglie tonde 2 e 3 vie con doccia
 2-3 way thermostat square rosettes and round handles trim set with hand shower

Dimensions: rosoni | rosettes 70x70 mm
 Material: ottone | brass









Notes: da abbinare con: **E176903** incasso termostatico 2 vie - **E176904** incasso termostatico 3 vie flessibile* con attacco speciale, non possono essere installati flessibili con attacco standard le estetiche possono essere installate su entrambi i moduli incasso verticale e orizzontale

to combine with: **E176903** 2-way thermostat concealed module - **E176904** 2-way thermostat concealed module flexible hose* with special connection, hoses with standard connection cannot be installed the trim set can be installed on both vertical and horizontal concealed modules



Functions:  thermostat  2 Way  3 Way

Finishes:

		Matt Colours		PVD Polished		PVD Brushed			
Chrome CR	Nickel Brushed NB								
		Matt Black MB	Matt White WM	Gold GO	Deep Black DB	High Brass HB	Copper CO	Gun Metal GM	Absolute Black AB

DIMENSIONS

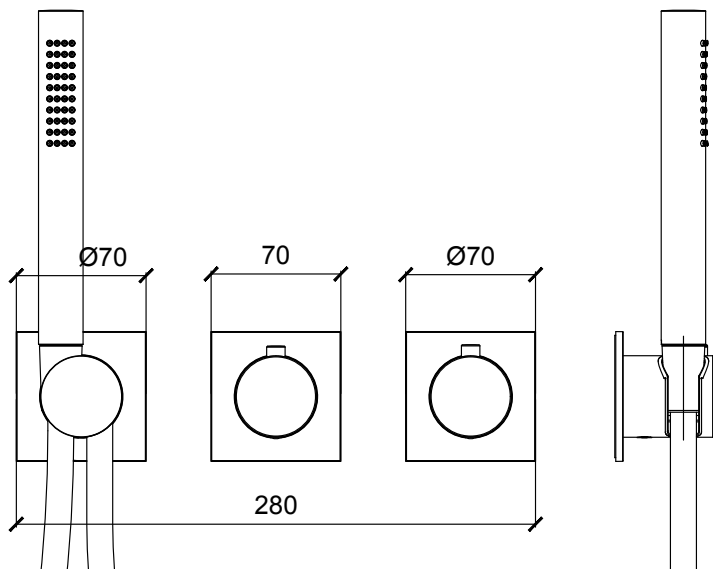

CURA DEL PRODOTTO

Per evitare danni al vostro bagno o all'apparecchiatura acquistata vi invitiamo ad osservare le seguenti raccomandazioni di utilizzo:

- Spurgare l'impianto prima di collegare l'apparecchio.
- Pulire periodicamente la fessura di erogazione acqua da eventuali depositi di calcare che potrebbero compromettere il corretto funzionamento.

Consiglio: L'installazione di un impianto di filtraggio e addolcitura delle acque migliora e prolunga la vita dei nostri apparecchi e dell'impianto stesso.

PULIZIA PARTI METALLICHE:

Per la semplice pulizia delle parti metalliche del prodotto è sufficiente usare un panno morbido e inumidito con acqua e sapone o un prodotto anticalcare.

Per evitare la formazione di macchie, dovute alla presenza di calcio nell'acqua, si consiglia di asciugare con un panno dopo ogni uso.

Consiglio: Si prega di usare solo detergenti naturali a base di sapone evitando quelli contenenti alcool, acido cloridrico o acido fosforico, candeggina, cloro, ecc., e quelli contenenti polveri abrasive.

PRODUCT CARE

To avoid damages to the purchased equipment, please observe the following recommendations for use:

- *Clean the plumbing before connecting the device.*
- *Periodically clean the water blade to avoid any limestone deposits that could compromise the good functioning.*

Advice: *The installation of a filter and water-softener system improves and extends the life of the devices and of the plant itself.*

CLEANING OF METAL PARTS:

For an easy cleaning of the metal parts of the product, simply use a soft cloth moistened in water and soap or an anti-limestone detergent.

To avoid spots caused by calcium in water, we advise drying with a cloth after each use.

Advice: *Please use only natural soap-based detergents avoiding those with alcohol, hydrochloric acid or phosphoric acid, bleach, chlorine etc. and those containing abrasive powders.*

PACKING



1

PRODOTTI CORRELATI | RELATED PRODUCTS



E176903

incasso termostatico 2 vie con doccia
2-way concealed module with hand shower



E176904

incasso termostatico 3 vie con doccia
3-way concealed module with hand shower