

**BOOK
2026**





Almar nel tempo

Almar over time

Almar à travers le temps

La storia di un'azienda è spesso intrecciata con quella del luogo da cui tutto ha avuto origine. Per Almar, quel luogo è un antico mulino ad acqua. Una passione che, negli anni, si è trasformata in un'eredità familiare tramandata con rispetto e dedizione e che arriva ai giorni nostri con Aldo e Marco Civelli alla direzione di Almar, un nome noto sui mercati internazionali che trova origine in una realtà familiare indissolubilmente legata al territorio da cui tutto ebbe inizio.

Per Almar l'acqua è da sempre al centro dei progetti, sviluppati per realizzare soluzioni che regalano momenti di rigenerazione e benessere come veri e propri stili di vita.

The story of a Company is often woven with that of its birthplace. For Almar, that origin lies within the walls of an ancient water mill.

A passion that, over the years, has evolved into a family legacy, passed down with respect and dedication, and that continues to this day under the leadership of Aldo and Marco Civelli at Almar: a name recognized on international markets, rooted in a family tradition inextricably linked to the territory where it all began.

Water has always been for Almar at the heart of our projects, which are designed to create concepts that offer regenerative moments and well-being, evolving from simple experiences into an authentic lifestyle choice.

L'histoire d'une entreprise est souvent liée à celle du lieu où tout a commencé. Pour Almar, ce lieu est un ancien moulin à eau. Une passion qui, au fil des années, s'est transformée en un héritage familial transmis avec respect et dévouement et qui arrive jusqu'à aujourd'hui avec Aldo et Marco Civelli à la direction d'Almar, un nom reconnu sur les marchés internationaux et profondément enraciné dans une tradition familiale liée au territoire d'origine.

Pour Almar, l'eau a toujours été au cœur des projets, développés pour créer des solutions capables d'offrir des moments de régénération et de bien-être comme de véritables styles de vie.



● **1969**

Fondazione di Civelli Gianluigi & C. snc, realtà artigiana specializzata nella produzione di stampi per il settore rubinetteria

Foundation of Civelli Gianluigi & C. snc, an artisanal company specialized in the production of molds for the tapware sector

Fondation de Civelli Gianluigi & C. snc, entreprise artisanale spécialisée dans la production de moules pour le secteur de la robinetterie

● **1996**

Fondazione di ALMAR e avvio della produzione di accessori per rubinetteria conto terzi

Foundation of ALMAR and start of the production of tapware accessories for third parties

Fondation d'ALMAR et lancement de la production d'accessoires pour robinetterie en sous-traitance

● **2006**

Ingresso nelle principali fiere internazionali di settore

Participation in the main international industry fairs

Participation aux principaux salons internationaux du secteur

● **2015**

Inaugurazione del nuovo sito produttivo di Cocquio Trevisago

Inauguration of the new production facility in Cocquio Trevisago

Inauguration du nouveau site de production de Cocquio Trevisago

● **2018**

Implementazione del rivestimento interno PVD (Physical Vapor Deposition) nei processi produttivi

Implementation of internal PVD (Physical Vapor Deposition) coating in production processes

Mise en oeuvre du revêtement interne PVD (Physical Vapor Deposition) dans les processus de production.

● **2019**

Incremento della capacità produttiva con l'avvio del nuovo reparto di torneria e fresatura (acciaio e ottone) e il rafforzamento del reparto PVD

Increased production capacity through the launch of the new turning and milling department (stainless steel and brass) and the expansion of the PVD department

Augmentation de la capacité de production grâce à la mise en service du nouveau département de tournage et de fraisage (acier inoxydable et laiton) et au renforcement du département PVD

● **2020**

Apertura dello showroom aziendale, spazio espositivo dedicato alle collezioni

Opening of the company showroom, an exhibition space dedicated to the collections

Ouverture du showroom de l'entreprise, espace d'exposition dédié aux collections

● **2025**

Apertura del terzo sito produttivo a Cocquio Trevisago, dedicato alla lavorazione dell'acciaio

Opening of the third production facility in Cocquio Trevisago, dedicated to stainless steel processing

Ouverture du troisième site de production à Cocquio Trevisago, dédié à l'usage de l'acier inoxydable

● **2026**

Apertura del quarto sito produttivo a Barasso, dedicato alla lavorazione delle finiture PVD

Opening of the fourth facility in Barasso, dedicated exclusively to PVD finishing processes

Ouverture du quatrième site à Barasso, dédié exclusivement à la réalisation des finitions PVD

Indice | Contents | Sommaire

acciaio AISI 316L AISI 316L stainless steel <i>acier AISI 316L</i>	<p>Acciaio AISI 316L 4</p> <p>Modular push 2 vie tondo con soffione Beam e doccia Easysteel 24</p> <p>Modular termostatico 2 vie tondo con soffione Emotion e doccia Easysteel 28</p> <p>Modular termostatico 3 vie con Sway quadro e doccia Easysteel 32</p> <p>Colonna doccia con termostatico esterno 36</p> <p>Saliscendi con termostatico esterno e doccia Easysteel 40</p> <p>Core termostatico 3 vie con soffione Smart e doccia Easysteel 42</p> <p>Core meccanico 2 vie con soffione Emotion tondo e doccia Easysteel 44</p> <p>Core termostatico 2 vie con soffione Emotion quadro a soffitto e doccia Easysteel 46</p> <p>High Flow 3 vie con soffione Temptation a soffitto e doccia Easysteel 48</p> <p>High Flow con saliscendi e doccia Easysteel 49</p> <p>Core meccanico con saliscendi e doccia Easysteel 50</p> <p>Placca WC con tasti rettangolari, Kit miscelatore WC con supporto e shut off Athena 52</p> <p>PVD Gun Metal 54</p> <p>Core termostatico 3 vie con soffione Temptation e doccia Easysteel - <i>PVD Gun Metal</i> 74</p> <p>Colonna doccia con termostatico esterno e soffione Emotion e doccia Easysteel - <i>PVD Absolute Black</i> 76</p> <p>Modular meccanico 3 vie con soffione Emotion quadro e doccia Easysteel - <i>PVD Copper</i> 79</p> <p>Core termostatico 2 vie con soffione Emotion quadro e doccia Easysteel - <i>PVD Copper</i> 88</p> <p>High Flow 2 vie con soffione Emotion tondo con doccia Easysteel - <i>PVD High Brass</i> 90</p>
ottone brass <i>laiton</i>	<p>PVD Copper 94</p> <p>High Flow 3 vie con soffione Temptation a soffitto e doccia Posh - <i>PVD Copper</i> 114</p> <p>Modular Push 2 vie con soffione Sway e doccia Stick Velvet - <i>PVD High Brass</i> 118</p> <p>Saliscendi con doccia Posh - <i>PVD High Brass</i> 126</p> <p>Core push 3 vie con soffione Temptation e doccia Posh - <i>PVD High Brass</i> 130</p> <p>Core 3 vie con soffione Temptation e doccia Sense Massage - <i>PVD Gold</i> 132</p> <p>High Flow 3 vie con soffione Temptation e doccia Easybrass - <i>PVD Deep Black</i> 138</p> <p>Modular 3 vie quadro con soffione Temptation e doccia Easybrass - <i>Matt Black</i> 140</p> <p>High Flow 2 vie tondo con soffione Emotion e doccia Sense Icicle - <i>Matt Black</i> 142</p> <p>Core meccanico 3 vie con soffione Emotion e doccia Emotion - <i>Matt Black</i> 144</p> <p>Core termostatico 2 vie con soffione Emotion e doccia Sense Massage - <i>Matt White</i> 146</p> <p>High Flow 2 vie con soffione Temptation e doccia Easybrass - <i>Chrome</i> 148</p> <p>Modular termostatico 2 vie con soffione Beam e doccia Easybrass - <i>Chrome</i> 150</p> <p>High Flow 5 vie con soffione Temotion e doccia Thin - <i>Chrome</i> 152</p> <p>Core 3 vie con soffione Temptation e doccia Sense Icicle - <i>Chrome</i> 156</p> <p>Core Push 2 vie con cascata e doccia Sense Massage - <i>Chrome</i> 160</p> <p>High Flow 4 vie con soffione Smart e doccia Thin - <i>Chrome</i> 161</p> <p>High Flow 5 vie con soffione Temptation e doccia Thin - <i>Chrome</i> 164</p> <p>High Flow 5 vie con soffione Temptation 950 e doccia Thin - <i>Chrome</i> 166</p> <p>Kit colonne doccia - <i>Chrome</i> 167</p>
	<p>Finiture 169</p> <p>Programma docce Velvet 172</p> <p>Doccia Sense 174</p> <p>Doccia Stick Velvet 177</p> <p>Doccia Velvet 179</p> <p>Getti Doccia 182</p> <p>Getti Laterali 185</p> <p>Controllo dell'Acqua 187</p> <p>Modular 190</p> <p>Core 194</p> <p>High Flow 198</p>

Acciaio AISI 316L
AISI 316L Stainless Steel
Acier AISI 316L

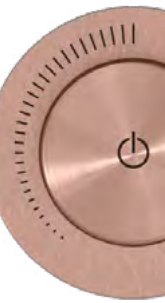



Acciaio AISI 316L

L'acciaio inox AISI 316L nasce come materiale destinato ad applicazioni esterne e tecniche, dove la resistenza alla corrosione e agli agenti atmosferici rappresenta un requisito fondamentale. L'affidabilità e la versatilità di questo materiale ne hanno consolidato l'utilizzo nel tempo.

Oggi l'acciaio inox 316L, applicato a sistemi doccia, rubinetteria e accessori, consente di realizzare prodotti di design, prestigiosi e durevoli, capaci di mantenere nel tempo precisione funzionale e qualità estetiche, integrandosi con naturalezza nell'architettura contemporanea del bagno.

Originally engineered for external and technical applications, AISI 316L stainless steel is defined by its exceptional resistance to corrosion and weather conditions. Its reliability in exposed contexts and under critical environmental conditions has consolidated its use over time. AISI 316 stainless steel - today used in shower concepts, faucets and fittings and bathroom accessories - enables the

manufacture of prestigious design products maintaining functional precision and an aesthetic quality over time, becoming naturally part of the contemporary architecture of the bathroom.

L'acier inoxydable AISI 316L a été développé pour des applications extérieures et techniques, où la résistance à la corrosion et aux agents atmosphériques constitue une exigence fondamentale. Sa fiabilité dans des environnements exposés et dans des conditions exigeantes a consolidé son utilisation au fil du temps.

Aujourd'hui, l'acier inoxydable 316, appliqué aux systèmes de douche, à la robinetterie et aux accessoires, permet de réaliser des produits de design prestigieux et durables capables de conserver précision fonctionnelle et qualité esthétique dans le temps, en s'intégrant naturellement dans l'architecture contemporaine de la salle de bain.





E044306 Soffione Velvet tondo Ø300mm
· Velvet round shower head Ø300mm · Tête
de douche Velvet ronde Ø300mm

E021093 Braccio doccia con canna curva
90° e rosone tondo L350mm · Shower
arm with 90° curved tube and round flange
L350mm · Bras de douche avec tube courbé
à 90° et rosace ronde L350mm

E300003 Mensola portasapone · Soap
shelf · Étagère porte-savon

E082129 Doccia Posh · Posh hand shower
· Douchette Posh

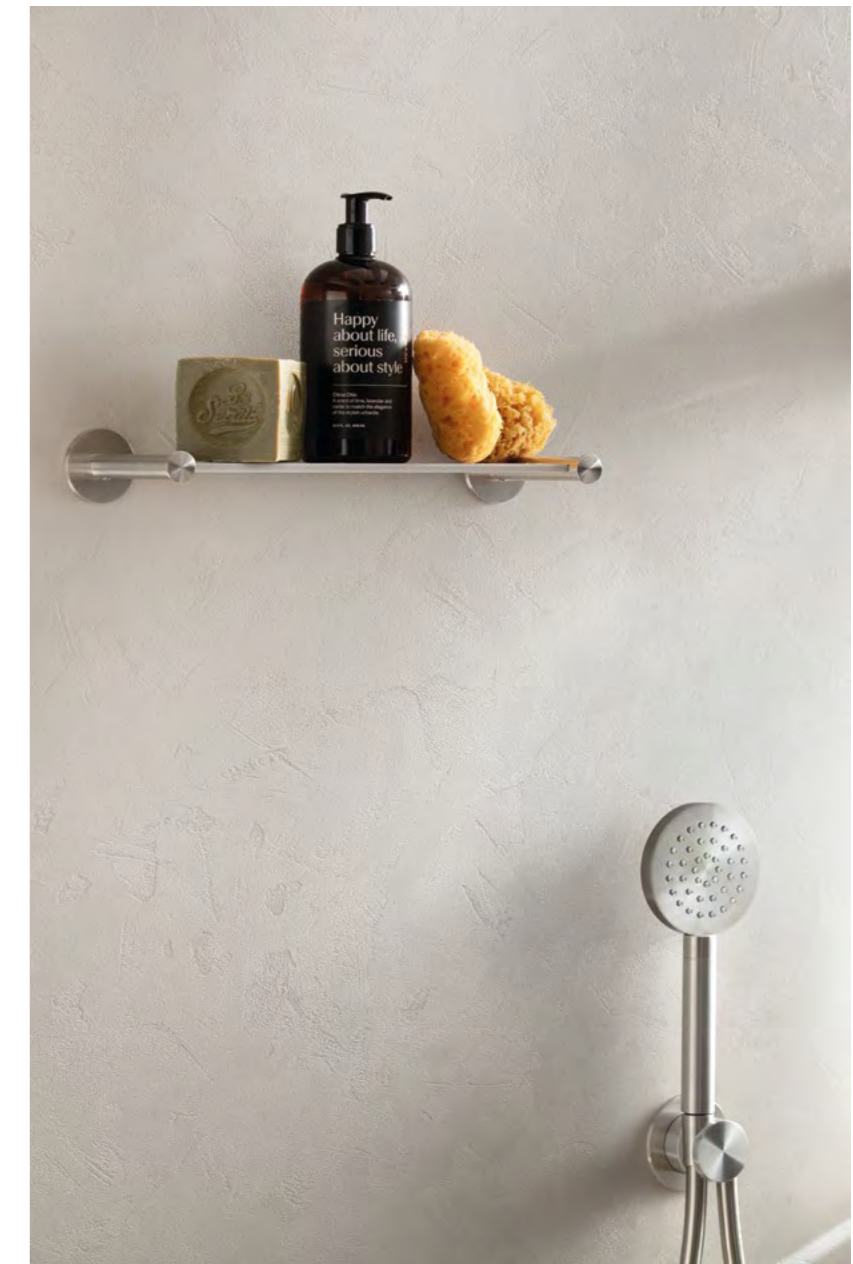



E310002 Porta accappatoio · Bathrobe hook · Porte-peignoir

E082126 Doccia Stick Velvet · Stick Velvet hand shower · Douchette Stick Velvet

E095047 Presa d'acqua Modular con rosone tondo · Modular water outlet with round rosette · Prise d'eau Modular avec rosace ronde

C084049 Flessibile per Modular L150cm · Flexible hose for Modular L150cm · Flexible pour Modular L150cm

serie line

E180145 Estetica Modular Meccanico 2 vie rosoni tondi e leva a righe · Modular Mechanical 2-way trim set with round rosettes and grooved lever · Façade Modular Mécanique 2 voies avec rosaces rondes et levier rainuré



serie line

E216001 Miscelatore vasca 2 vie a pavimento con leva a righe · Freestanding 2-way bathtub faucet with grooved lever · Mitigeur baignoire 2 voies sur pied avec levier rainuré





serie line

E214028 Miscelatore lavabo 2 fori con leva a righe · 2-hole basin faucet with grooved lever · Mitigeur lavabo 2 trous avec levier rainuré



serie bead

E214029 Miscelatore lavabo 2 fori con leva a pois · 2-hole basin faucet with dotted lever · Mitigeur lavabo 2 trous avec levier à pois



serie line

E214013 Miscelatore monocomando lavabo con leva a righe · Single-lever basin faucet with grooved lever · *Mitigeur monocommande lavabo avec levier rainuré*



serie bead

E214014 Miscelatore monocomando lavabo con leva a pois · Single-lever basin faucet with dotted lever · *Mitigeur monocommande lavabo avec levier à pois*

serie line

E214019 Miscelatore monocomando
lavabo alto con leva a righe · Tall single-
lever basin faucet with grooved lever ·
*Mitigeur monocommande lavabo haut avec
levier rainuré*



E085003 Porta saponetta da parete · Wall-
mounted soap dish · *Porte-savonnette mural*

E070000 Bicchiere portaspazzolino da
appoggio · Countertop toothbrush holder ·
Verre porte-brosses à dents à poser

**serie line**

E210106 Miscelatore lavabo 3 fori da parete con canna lunga e leve a righe · Wall-mounted 3-hole basin faucet trim set with long spout and grooved levers · *Façade mitigeur lavabo mural 3 trous avec bec long et leviers rainurés*



E330002 Placca WC con pulsanti tondi asimmetrici · WC flush plate with asymmetric round buttons · *Plaque WC avec boutons ronds asymétriques*

E305004 Porta asciugamano L300mm · Towel rail L300mm · *Porte-serviettes L300mm*

E315001 Porta rotolo destro · Right-hand toilet paper holder · *Porte-rouleau droit*

E068004 Porta scopino WC da appoggio · Toilet brush holder · *Porte-brosse WC à poser*

serie line

E214022 Miscelatore monocomando bidet con leva a righe · Single-lever bidet faucet with grooved lever · *Mitigeur monocommande bidet avec levier rainuré*

serie bead

E214023 Miscelatore monocomando bidet con leva a pois · Single-lever bidet faucet with dotted lever · *Mitigeur monocommande bidet avec levier à pois*

Modular push 2 vie tondo con soffione Beam e doccia Easysteel



E044287 Soffione Beam monogetto da parete · Wall-mounted Beam single-jet shower head · Tête de douche Beam monojet murale

E180433 Estetica Modular Termostatico Push 2 vie con rosoni e maniglie tonde, completa di doccia Easysteel · Modular Thermostatic Push 2-way trim set with round rosettes and round handles, complete with Easysteel hand shower · Façade Modular Thermostatique Push 2 voies avec rosaces rondes et poignées rondes, complète avec douchette Easysteel

E082095 Doccia Easysteel · Easysteel hand shower · Douchette Easysteel

E310001 Porta accappatoio · Bathrobe hook · Porte-peignoir

E305001 Porta asciugamani L450mm · Towel rail L450mm · Porte-serviettes L450mm

Un sistema doccia inserito in un'architettura essenziale, dove superfici continue e forme precise creano un equilibrio visivo raffinato, ordinato ed elegante. La rubinetteria Modular termostatica Push si sviluppa in modo lineare integrando getti Velvet Rain e doccia.

L'acciaio inox AISI 316L spazzolato naturale emerge come elemento di contrasto e continuità, creando un ambiente moderno e sobrio, ancor più valorizzato dall'abbinamento con elementi scuri e accessori dalle linee essenziali.

A shower system integrated into an essential architectural framework, where continuous surfaces and precise alignments build a rigorous and elegant visual balance. Our Modular Thermostatic Push range features a linear layout, incorporating Velvet Rain shower and a hand shower.

The natural brushed AISI 316L stainless steel emerges as an

element of both contrast and continuity, creating modern and sober interior spaces, further enhanced by the pairing with dark elements and essential, minimalist accessories.

Un système de douche intégré dans une architecture essentielle où surfaces continues et formes précises créent un équilibre visuel raffiné, ordonné et élégant. La robinetterie Modular thermostatique Push se développe de manière linéaire en intégrant les jets Velvet Rain et la douchette. L'acier inoxydable AISI 316L brossé naturel apparaît comme un élément de contraste et de continuité, créant un environnement moderne et sobre, encore renforcé par l'association avec des éléments foncés et des accessoires aux lignes essentielles.



E180433 Estetica Modular Termostatico Push 2 vie con rosoni e maniglie tonde, completa di doccia Easysteel · Modular Thermostatic Push 2-way trim set with round rosettes and round handles, complete with Easysteel hand shower · *Façade Modular Thermostatique Push 2 voies avec rosaces rondes et poignées rondes, complète avec douchette Easysteel*

E082095 Doccia Easysteel · Easysteel hand shower · *Douchette Easysteel*



E044287 Soffione Beam monogetto da parete · Wall-mounted Beam single-jet shower head · *Tête de douche Beam monojet murale*

Modular termostatico 2 vie tondo con soffione Emotion e doccia Easysteel

E044072 Soffione Emotion tondo Ø300mm · Emotion round shower head Ø300mm · Tête de douche Emotion ronde Ø300mm

E021093 Braccio doccia con canna curva 90° e rosone tondo L350mm · Shower arm with 90° curved tube and round flange L350mm · Bras de douche avec tube courbé à 90° et rosace ronde L350mm

E180133 Estetica Modular Termostatico 2 vie con rosoni e maniglie tonde, completa di doccia Easysteel · Modular Thermostatic 2-way trim set with round rosettes and round handles, complete with Easysteel hand shower · Façade Modular Thermostatique 2 voies avec rosaces rondes et poignées rondes, complète avec douchette Easysteel

E082095 Doccia Easysteel · Easysteel hand shower · Douchette Easysteel

E300001 Mensola portasapone · Soap shelf · Étagère porte-savon

E310001 Porta accappatoio · Bathrobe hook · Porte-peignoir

Doccia e vasca dalle linee essenziali e pulite creano un ambiente elegante e funzionale. Il sistema Modular termostatico a 2 vie con comandi tondi accompagna entrambe le funzioni.

A shower and bathtub with their essential and clean lines create an elegant and functional space. The 2-way Modular thermostatic system with round controls serves both functions.

Douche et baignoire aux lignes essentielles et épurées créent un environnement élégant et fonctionnel. Le système Modular thermostatique 2 voies avec commandes rondes accompagne les deux fonctions.

E180135 Estetica Modular Termostatico 2 vie bordo vasca con rosoni e maniglie tonde e bocca curva, completa di doccia Easysteel · Modular Thermostatic 2-way deck-mounted bathtub trim set with round rosettes, round handles and curved spout, complete with Easysteel hand shower · Façade Modular Thermostatique 2 voies avec rosaces rondes et poignées rondes, complète avec douchette Easysteel





E044072 Soffione Emotion tondo Ø300mm · Emotion round shower head Ø300mm · Tête de douche Emotion ronde Ø300mm

E021093 Braccio doccia con canna curva 90° e rosone tondo L350mm · Shower arm with 90° curved tube and round flange L350mm · Bras de douche avec tube courbé à 90° et rosace ronde L350mm

E300001 Mensola portasapone · Soap shelf · Étagère porte-savon

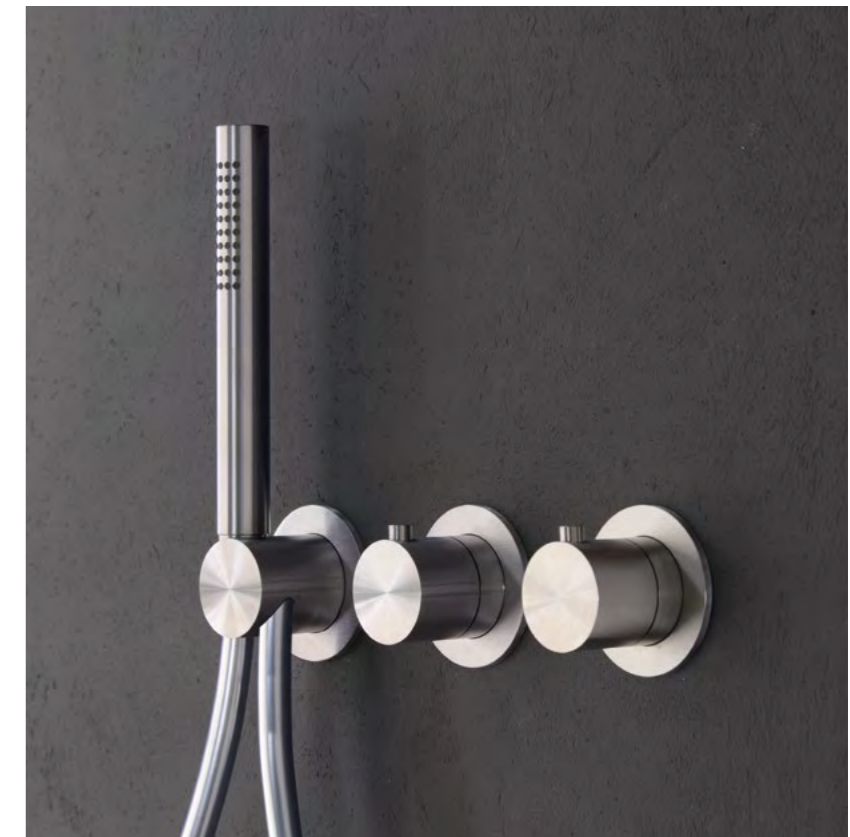

E180133 Estetica Modular Termostatico 2 vie con rosoni e maniglie tonde, completa di doccia Easysteel · Modular Thermostatic 2-way trim set with round rosettes and round handles, complete with Easysteel hand shower · Façade Modular Thermostatique 2 voies avec rosaces rondes et poignées rondes, complète avec douchette Easysteel

E082095 Doccia Easysteel · Easysteel hand shower · Douchette Easysteel

Modular termostatico 3 vie con Sway quadro e doccia Easysteel

E044300 Soffione Sway quadro · Sway square shower head · Tête de douche Sway carrée

E003194 Estetica cascata XL a incasso · XL built-in waterfall trim set · Façade cascade XL encastrable

E180183 Estetica Modular Termostatico 3 vie con rosoni quadri e maniglie tonde, completa di doccia Easysteel · Modular Thermostatic 3-way trim set with square rosettes and round handles, complete with Easysteel hand shower · Façade Modular Thermostatique 3 voies avec rosaces carrées et poignées rondes, complète avec douchette Easysteel

E082095 Doccia Easysteel · Easysteel hand shower · Douchette Easysteel

Un ambiente bagno definito da un design deciso e da superfici spazzolate, per un sistema doccia elegante e di carattere.

Il sistema Modular termostatico a 3 vie con comandi quadri gestisce le diverse funzioni.

L'acciaio inox AISI 316L spazzolato si abbina alle texture delle superfici e agli accessori moderni e lineari.

Bold design meets brushed finishes to create a shower system of elegance and personality.

Our 3-function thermostatic Modular system with round controls manages the different water functions.

The brushed AISI 316L stainless steel harmonizes beautifully with textured materials and minimalist, modern accessories.

Un environnement salle de bain défini par un design marqué et des surfaces brossées, pour un système de douche élégant et de caractère.

Le système Modular thermostatique 3 voies avec commandes carrées gère les différentes fonctions.

L'acier inoxydable AISI 316L brossé s'associe aux textures des surfaces et aux accessoires modernes et linéaires.





E044300 Soffione Sway quadro · Sway square shower head · Tête de douche Sway carrée

E180183 Estetica Modular Termostatico 3 vie con rosoni e maniglie tonde, completa di doccia Easysteel · Modular Thermostatic 3-way trim set with round rosettes and round handles, complete with Easysteel hand shower · Façade Modular Thermostatique 3 voies avec rosaces rondes et poignées rondes, complète avec douchette Easysteel

E082095 Doccia Easysteel · Easysteel hand shower · Douchette Easysteel





Acciaio AISI 316L | AISI 316L Stainless Steel | Acier AISI 316L

Colonna doccia con termostatico esterno

La colonna doccia con termostatico esterno a 2 vie integra il soffione Velvet e la doccia in una composizione verticale ordinata e funzionale, valorizzata da un getto vellutato e silenzioso. L'acciaio inox AISI 316L spazzolato naturale si inserisce con discrezione per creare un equilibrio visivo sobrio e contemporaneo.

La colonne de douche 2 voies avec commande thermostatique apparent intègre la tête de douche Velvet et la douchette dans une composition verticale ordonnée et fonctionnelle, mise en valeur par un jet doux et silencieux.

L'acier inoxydable AISI 316L brossé naturel s'intègre avec discrétion pour créer un équilibre visuel sobre et contemporain.

The shower column with an external thermostatic 2-way control integrates the Velvet shower head and the hand shower into a clean and functional vertical composition, further enhanced by a velvety and silent water flow.

The natural brushed AISI AISI 316L stainless steel blends in discreetly, creating a refined and contemporary visual balance.



E405001 Colonna doccia completa con termostatico esterno, soffione Velvet e doccia Easysteel · Complete shower column with exposed thermostatic faucet, Velvet shower head and Easysteel hand shower · Colonne de douche complète avec commande thermostatique apparente, tête de douche Velvet et douchette Easysteel

E082095 Doccia Easysteel · Easysteel hand shower · Douchette Easysteel

C084021 Flessibile in PVC in finitura L150cm · PVC flexible hose in matching finish L150cm · Flexible en PVC avec finition assortie L150cm



E044290 Soffione Velvet tondo Ø230mm · Velvet round shower head Ø230mm · Tête de douche Velvet ronde Ø230mm



E087073 Saliscendi con rosoni tondi L900mm · Slide bar with round rosettes L900mm · Barre de douche avec rosaces rondes L900mm

E082095 Doccia Easysteel · Easysteel hand shower · Douchette Easysteel

C084021 Flessibile in PVC in finitura L150cm · PVC flexible hose in matching finish L150cm · Flexible en PVC avec finition assortie L150cm

Acciaio 316 | 316 Stainless Steel | Acier 316

Saliscendi con termostatico esterno e doccia Easysteel

E400002 Termostatico esterno · Exposed thermostatic mixer · Thermostatique apparent



Core termostatico 3 vie con soffione Smart e doccia Easysteel

E044199 Soffione Smart 2 funzioni · Smart 2-function shower head · Tête de douche Smart à 2 fonctions

E082095 Doccia Easysteel · Easysteel hand shower · Douchette Easysteel

E095034 Presa d'acqua con supporto tondo per doccia e rosone quadro · Water outlet with round hand shower support and square flange · Prise d'eau avec support rond pour douche et rosace carrée

C084052 Flessibile in acciaio 316 L150cm · 316 stainless steel flexible hose L150cm · Flexible en acier inoxydable 316 L150cm

E300001 Mensola portasapone · Soap shelf · Étagère porte-savon

E176883 Estetica Core Termostatico 3 vie rettangolare con maniglie tonde · Core Thermostatic rectangular 3-way trim set with round handles · Façade Core Thermostatique rectangulaire 3 voies avec poignées rondes



Core meccanico 2 vie con soffione Emotion tondo e doccia Easysteel

E044072 Soffione Emotion tondo
Ø300mm · Emotion round shower head
Ø300mm · Tête de douche Emotion ronde
Ø300mm

E021095 Braccio doccia con canna
curva 90° e rosone quadro L350mm ·
Shower arm with 90° curved tube and
square flange L350mm · Bras de douche
avec tube courbé à 90° et rosace carrée
L350mm

E082095 Doccia Easysteel · Easysteel
hand shower · Douchette Easysteel

E095034 Presa d'acqua con supporto
tondo per doccia e rosone quadro · Water
outlet with round hand shower support and
square flange · Prise d'eau avec support
rond pour douchette et rosace carrée

C084052 Flessibile in acciaio 316 L150cm
· 316 stainless steel flexible hose L150cm ·
Flexible en acier inoxydable 316 L150cm

E186582 Estetica Core Meccanico 2 vie
rettangolare con deviatore automatico ·
Core Mechanical rectangular 2-way
trim set with automatic diverter · Façade
Core Mécanique rectangulaire 2 voies avec
inverseur automatique

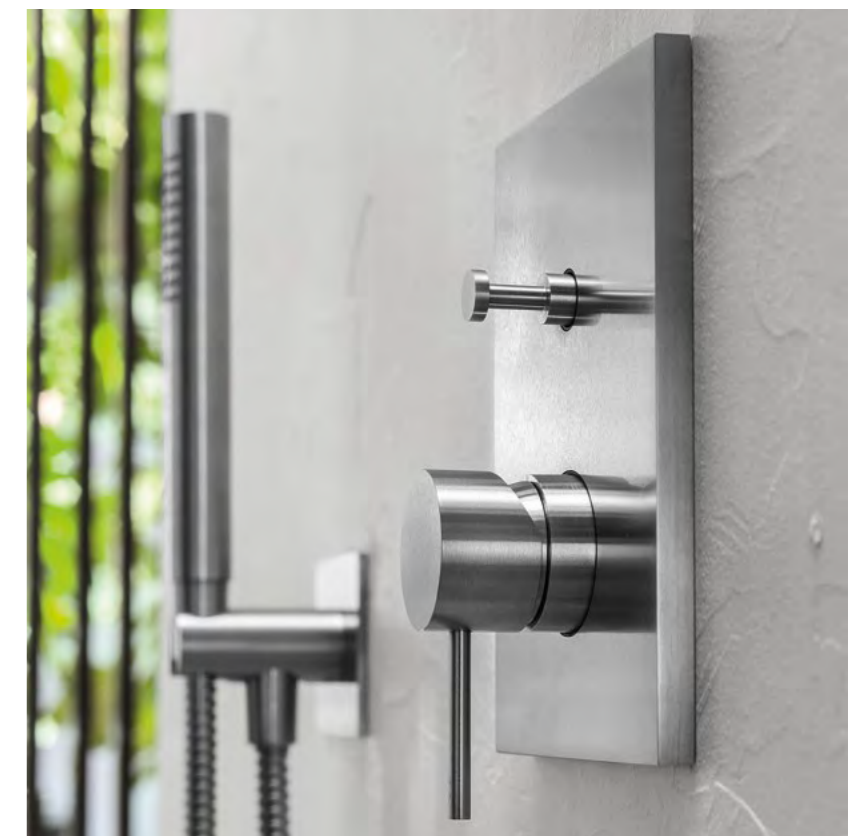



Core termostatico 2 vie con soffione Emotion quadro a soffitto e doccia Easysteel

E044234 Soffione Emotion quadro 250mm
 · Emotion square shower head 250mm ·
 Tête de douche Emotion carrée 250mm

E021094 Braccio doccia a soffitto con rosone quadro L300mm · Ceiling shower arm with square flange L300mm · Bras de douche plafond avec rosace carrée L300mm

E082095 Doccia Easysteel · Easysteel hand shower · Douchette Easysteel

E095034 Presa d'acqua con supporto tondo per doccia e rosone quadro · Water outlet with round hand shower support and square flange · Prise d'eau avec support rond pour douchette et rosace carrée

C084052 Flessibile in acciaio 316 L150cm · 316 stainless steel flexible hose L150cm · Flexible en acier inoxydable 316 L150cm

E176882 Estetica Core Termostatico 2 vie rettangolare con maniglie tonde · Core Thermostatic rectangular 2-way trim set with round handles · Façade Core Thermostatique rectangulaire 2 voies avec poignées rondes



High Flow 3 vie con soffione Temptation a soffitto e doccia Easysteel

E044024 Soffione Temptation quadro monogetto 500mm · Temptation square single-jet shower head 500mm · Tête de douche Temptation carrée monojet 500mm

E044086 Cascata esterna a parete · Wall-mounted external waterfall · Cascade murale apparente

E082095 Doccia Easysteel · Easysteel hand shower · Douchette Easysteel

E095034 Presa d'acqua con supporto tondo per doccia e rosone quadro · Water outlet with round hand shower support and square flange · Prise d'eau avec support rond pour douchette et rosace carrée

C084052 Flessibile in acciaio 316 L150cm · 316 stainless steel flexible hose L150cm · Flexible en acier inoxydable 316 L150cm

E180083 Estetica High Flow 3 vie con rosoni quadri e maniglie tonde · High Flow 3-way trim set with square rosettes and round handles · Façade High Flow 3 voies avec rosaces carrées et poignées rondes



Acciaio AISI 316L | AISI 316L Stainless Steel | Acier AISI 316L

High Flow con saliscendi e doccia Easysteel

E087073 Saliscendi con rosoni tondi L900mm · Slide bar with round rosettes L900mm · Barre de douche avec rosaces rondes L900mm

E082095 Doccia Easysteel · Easysteel hand shower · Douchette Easysteel

E095033 Presa d'acqua tonda con rosone tondo · Round water outlet with round rosette · Prise d'eau ronde avec rosace ronde

C084052 Flessibile in acciaio 316 L150cm · 316 stainless steel flexible hose L150cm · Flexible en acier inoxydable 316 L150cm

E180031 Estetica High Flow 1 via con rosoni tondi e maniglie tonde · High Flow 1-way trim set with round rosettes and round handles · Façade High Flow 1 voie avec rosaces rondes et poignées rondes

Acciaio AISI 316L | AISI 316L Stainless Steel | Acier AISI 316L

Core meccanico con saliscendi e doccia Easysteel

E087069 Saliscendi con rosoni quadri e presa d'acqua integrata L810 mm · Slide bar with square rosettes and integrated water outlet L810mm · Barre de douche avec rosaces carrées et prise d'eau intégrée L810mm

E082095 Doccia Easysteel · Easysteel hand shower · Douchette Easysteel

C084052 Flessibile in acciaio 316 L150cm · 316 stainless steel flexible hose L150cm · Flexible en acier inoxydable 316 L150cm

E186581 Estetica Core Meccanico 1 via rettangolare con maniglia tonda · Core Mechanical 1-way rectangular trim set with round handle · Façade Core Mécanique 1 voie rectangulaire avec poignée ronde

Placca WC con tasti rettangolari, Kit miscelatore WC con supporto e shut off Athena



E330001 Placca WC con tasti rettangolari
· WC flush plate with rectangular buttons ·
Plaque WC avec boutons rectangulaires

E315000 Porta rotolo · Toilet paper holder
· *Porte-rouleau*

E136014 Kit miscelatore WC con
supporto e shut off Athena · WC mixer kit
with support and Athena bidet hand shower
· *Kit mitigeur WC avec support et douchette
hygiénique Athena*





PVD Gun Metal

Le finiture PVD permettono di realizzare prodotti unici e resistenti che donano carattere a ogni ambiente.

PVD finishes enable the creation of unique, resilient products that bring a distinctive character to any space.

Les finitions PVD permettent de réaliser des produits uniques et résistants qui donnent du caractère à chaque environnement.





E044305 Soffione Velvet Light · Velvet Light shower head · Tête de douche Velvet Light

E003194 Estetica cascata XL a incasso · XL built-in waterfall trim set · Façade cascade XL encastrable

E180434 Estetica Modular Termostatico Push 3 vie con rosoni e maniglie tonde, completa di doccia Easysteel · Modular Thermostatic Push 3-way trim set with round rosettes and round handles, complete with Easysteel hand shower · Façade Modular Thermostatique Push 3 voies avec rosaces rondes et poignées rondes, complète avec douchette Easysteel

E082126 Doccia Stick Velvet · Stick Velvet hand shower · Douchette Stick Velvet

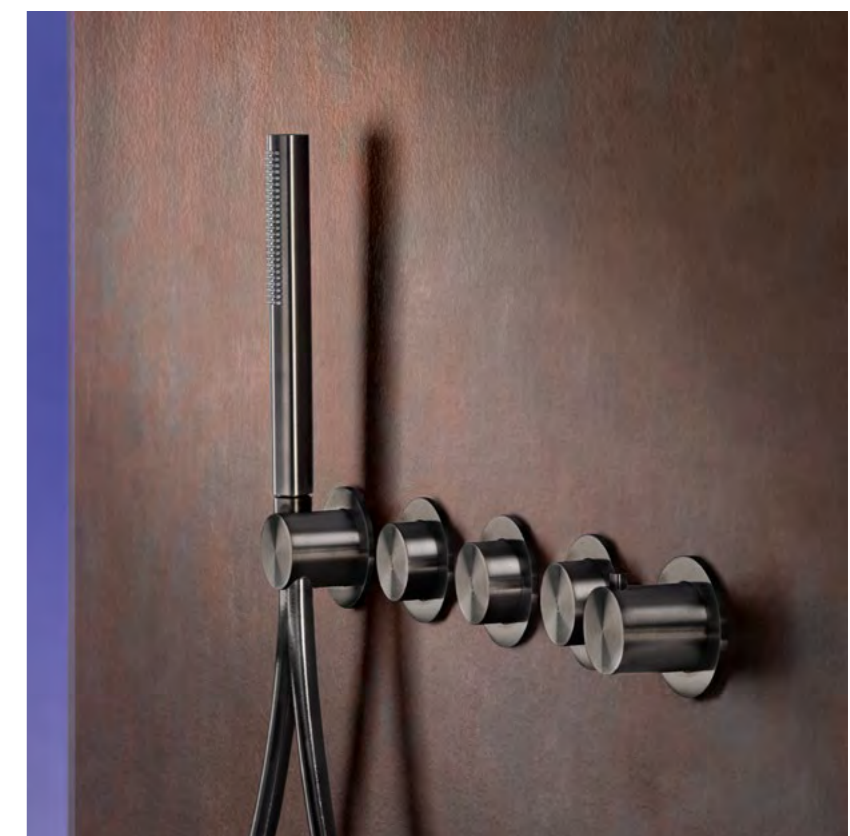



serie still

E210066 Miscelatore lavabo 2 fori da parete con leva sottile, rosoni tondi e canna lunga · Wall-mounted 2-hole basin faucet with slim lever, round rosettes and long spout · *Mitigeur lavabo mural à 2 trous avec levier fin, rosaces rondes et bec long*

E340001 Dispenser sapone liquido da parete · Wall-mounted liquid soap dispenser · *Distributeur de savon liquide mural*

E070001 Bicchiera portaspazzolino da parete · Wall-mounted toothbrush holder · *Porte-brosses à dents mural*

E305005 Porta asciugamano L450mm · Towel rail L450mm · *Porte-serviettes L450mm*



serie still

E210066 Miscelatore lavabo 2 fori da parete con leva sottile, rosoni tondi e canna lunga · Wall-mounted 2-hole basin faucet with slim lever, round rosettes and long spout · Mitigeur lavabo mural à 2 trous avec levier fin, rosaces rondes et bec long

E340001 Dispenser sapone liquido da parete · Wall-mounted liquid soap dispenser · Distributeur de savon liquide mural

E070001 Bicchiere portaspazzolino da parete · Wall-mounted toothbrush holder · Porte-brosses à dents mural





serie still

E214021 Miscelatore monocomando
lavabo alto con leva sottile · Tall single-
lever basin faucet with slim lever · *Mitigeur*
lavabo monocommande haut avec levier fin

serie still

E214033 Miscelatore lavabo 3 fori con leve sottili · 3-hole basin faucet with slim levers · Mitigeur lavabo à 3 trous avec leviers fins





serie still

E214027 Miscelatore monocomando lavabo freestanding con leva sottile · Freestanding single-lever basin faucet with slim lever · *Mitigeur lavabo monocommande sur pied avec levier fin*





serie still

E214021 Miscelatore monocomando lavabo alto con leva sottile · Tall single-lever basin faucet with slim lever · *Mitigeur lavabo monocommande haut avec levier fin*

E330003 Placca WC con pulsanti tondi simmetrici · WC flush plate with symmetrical round buttons · *Plaque WC avec boutons ronds symétriques*

E315002 Porta rotolo sinistro · Left-hand toilet paper holder · *Porte-rouleau gauche*

E068005 Porta scopino WC a parete · Wall-mounted toilet brush holder · *Porte-brosse WC mural*





ACCIAIO AISI 316L | AISI 316L STAINLESS STEEL | ACIER INOX AISI 316L

serie still

E214024 Miscelatore monocomando bidet con leva sottile · Single-lever bidet faucet with slim lever · Mitigeur bidet monocommande avec levier fin

E305004 Porta asciugamano L300mm · Towel rail L300mm · Porte-serviettes L300mm



ACCIAIO AISI 316L | AISI 316L STAINLESS STEEL | ACIER INOX AISI 316L

Core termostatico 3 vie con soffione Temptation e doccia Easysteel - PVD Gun Metal

E044109 Soffione Temptation Cascade
quadro 2 funzioni 500mm · Temptation
Cascade square 2-function shower head
500mm · Tête de douche Temptation
Cascade carrée 2 fonctions 500mm

E176883 Estetica Core Termostatico
3 vie rettangolare con maniglie tonde
· Core Thermostatic rectangular 3-way
trim set with round handles · Façade Core
Thermostatique rectangulaire 3 voies avec
poignées rondes

E095034 Presa d'acqua con supporto
tondo per doccia e rosone quadro · Water
outlet with round hand shower support and
square flange · Prise d'eau avec support
rond pour douchette et rosace carrée

E082095 Doccia Easysteel · Easysteel
hand shower · Douchette Easysteel

C084052 Flessibile in acciaio 316 L150cm
· 316 stainless steel flexible hose L150cm ·
Flexible en acier inoxydable 316 L150cm

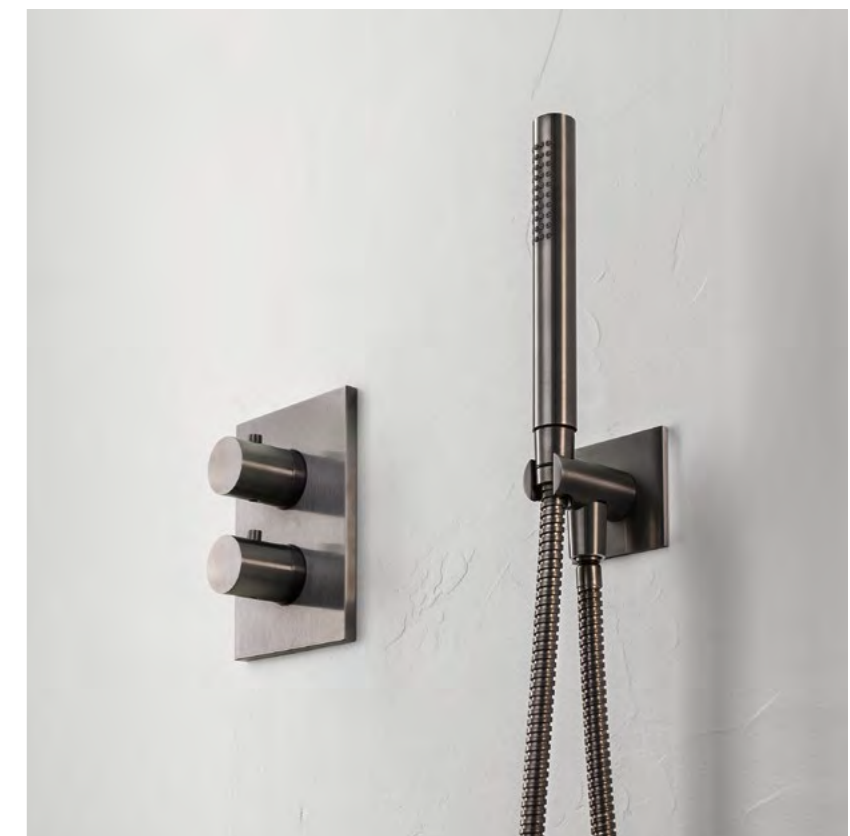



Colonna doccia con termostatico esterno e soffione Emotion e doccia Easysteel - PVD Absolute Black

E405001 Colonna doccia completa con termostatico esterno, soffione Velvet e doccia Easysteel · Complete shower column with exposed thermostatic faucet, Velvet shower head and Easysteel hand shower · Colonne de douche complète avec commande thermostatique apparente, tête de douche Velvet et douchette Easysteel

E044290 Soffione Velvet tondo Ø230mm · Velvet round shower head Ø230mm · Tête de douche Velvet ronde Ø230mm

E082095 Doccia Easysteel · Easysteel hand shower · Douchette Easysteel

C084021 Flessibile in PVC in finitura L150cm · PVC flexible hose in matching finish L150cm · Flexible en PVC avec finition assortie L150cm

serie still

E214021 Miscelatore monocomando lavabo alto con leva sottile · Tall single-lever basin faucet with slim lever · Mitigeur lavabo monocommande haut avec levier fin

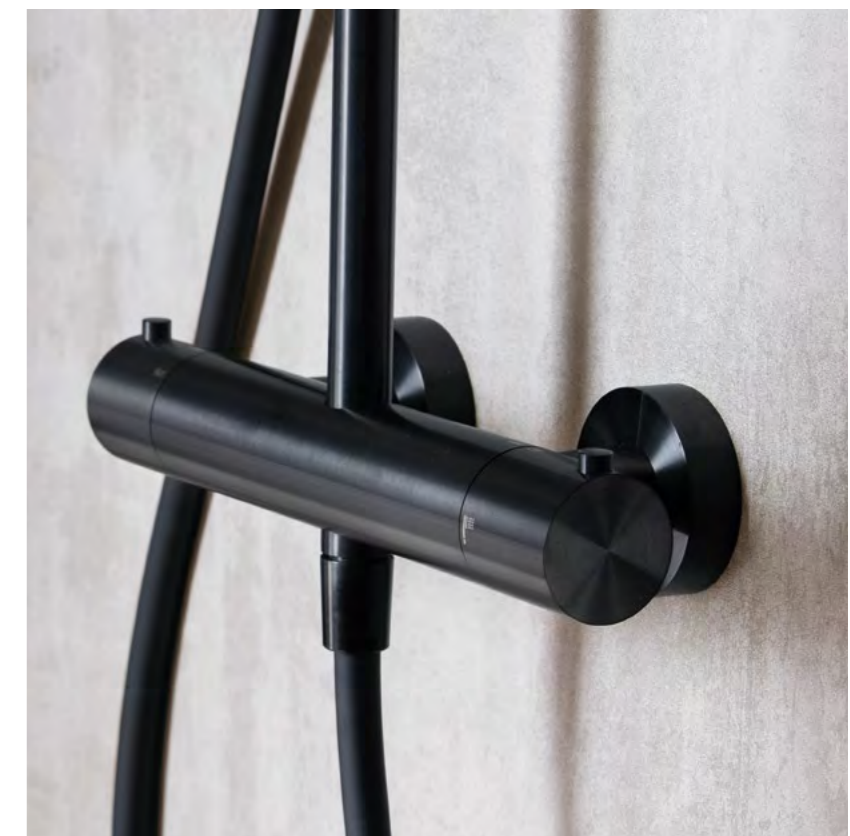



Modular meccanico 3 vie con soffione Emotion quadro e doccia Easysteel - PVD Copper

E044278 Soffione Velvet quadro 300mm ·
Velvet square shower head 300mm · *Tête
de douche Velvet carrée 300mm*

E021104 Braccio doccia con canna curva
90° e rosone quadro L420mm · Shower
arm with 90° curved tube and square flange
L420mm · *Bras de douche avec tube courbé
à 90° et rosace carrée L420mm*

E044273 Cascata XL esterna a parete
· Wall-mounted XL external waterfall ·
Cascade XL murale apparente

E310001 Porta accappatoio · Bathrobe
hook · *Porte-peignoir*

E180192 Estetica Modular Meccanico 3
vie con rosoni quadri e maniglie tonde,
completa di doccia Easysteel · Modular
Mechanical 3-way trim set with square
rosettes and round handles, complete with
Easysteel hand shower · *Façade Modular
Mécanique 3 voies avec rosaces carrées et
poignées rondes, complète avec douchette
Easysteel*

E082095 Doccia Easysteel · Easysteel
hand shower · *Douchette Easysteel*







E044278 Soffione Velvet quadro 300mm · Velvet square shower head 300mm · Tête de douche Velvet carrée 300mm

E021104 Braccio doccia con canna curva 90° e rosone quadro L420mm · Shower arm with 90° curved tube and square flange L420mm · Bras de douche avec tube courbé à 90° et rosace carrée L420mm

E044273 Cascata XL esterna a parete · Wall-mounted XL external waterfall · Cascade XL murale apparente

E180192 Estetica Modular Meccanico 3 vie con rosoni quadri e maniglie tonde, completa di doccia Easysteel · Modular Mechanical 3-way trim set with square rosettes and round handles, complete with Easysteel hand shower · Façade Modular Mécanique 3 voies avec rosaces carrées et poignées rondes, complète avec douchette Easysteel

E082095 Doccia Easysteel · Easysteel hand shower · Douchette Easysteel

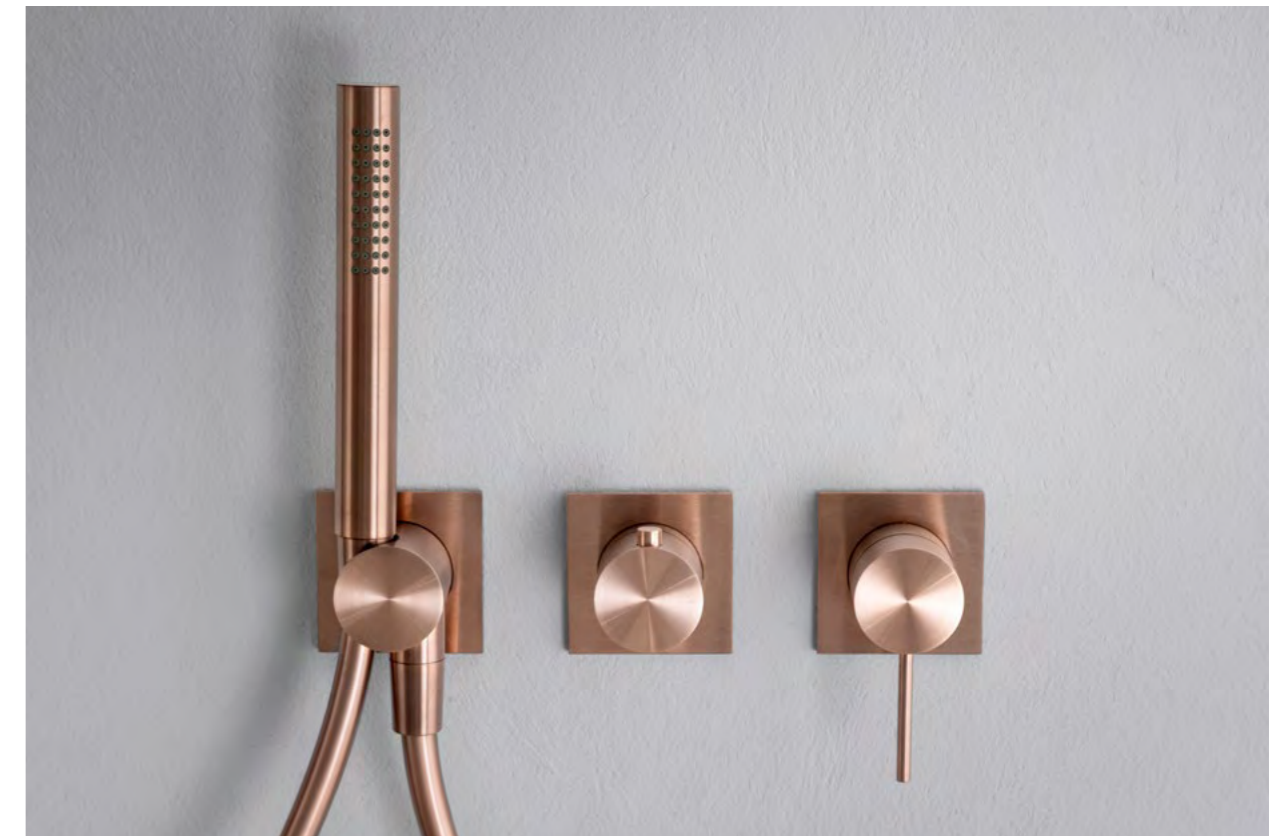



E180185 Estetica Modular Termostatico
 2 vie bordo vasca con rosoni quadri,
 maniglie tonde e bocca curva, completa
 di doccia Easysteel · Modular Thermostatic
 2-way deck-mounted bathtub trim set with
 square rosettes, round handles and curved
 spout, complete with Easysteel hand
 shower · *Façade Modular Thermostatique
 2 voies bord de baignoire avec rosaces
 carrées, poignées rondes et bec courbé,
 complète avec douchette Easysteel*

E082095 Doccia Easysteel · Easysteel
 hand shower · *Douchette Easysteel*

E300001 Mensola portasapone · Soap
 shelf · *Étagère porte-savon*



Core termostatico 2 vie con soffione Emotion quadro e doccia Easysteel - PVD Copper

E044234 Soffione Emotion quadro 250mm
· Emotion square shower head 250mm ·
Tête de douche Emotion carrée 250mm

E021094 Braccio doccia a soffitto con
rosone quadro L300mm · Ceiling shower
arm with square flange L300mm · *Bras de
douche plafond avec rosace carrée L300mm*

E082095 Doccia Easysteel · Easysteel
hand shower · *Douchette Easysteel*

E095034 Presa d'acqua con supporto
tondo per doccia e rosone quadro · Water
outlet with round hand shower support and
square flange · *Prise d'eau avec support
rond pour douchette et rosace carrée*

C084052 Flessibile in acciaio 316 L150cm
· 316 stainless steel flexible hose L150cm ·
Flexible en acier inoxydable 316 L150cm

E176882 Estetica Core Termostatico
2 vie rettangolare con maniglie tonde
· Core Thermostatic rectangular 2-way
trim set with round handles · *Façade Core
Thermostatique rectangulaire 2 voies avec
poignées rondes*

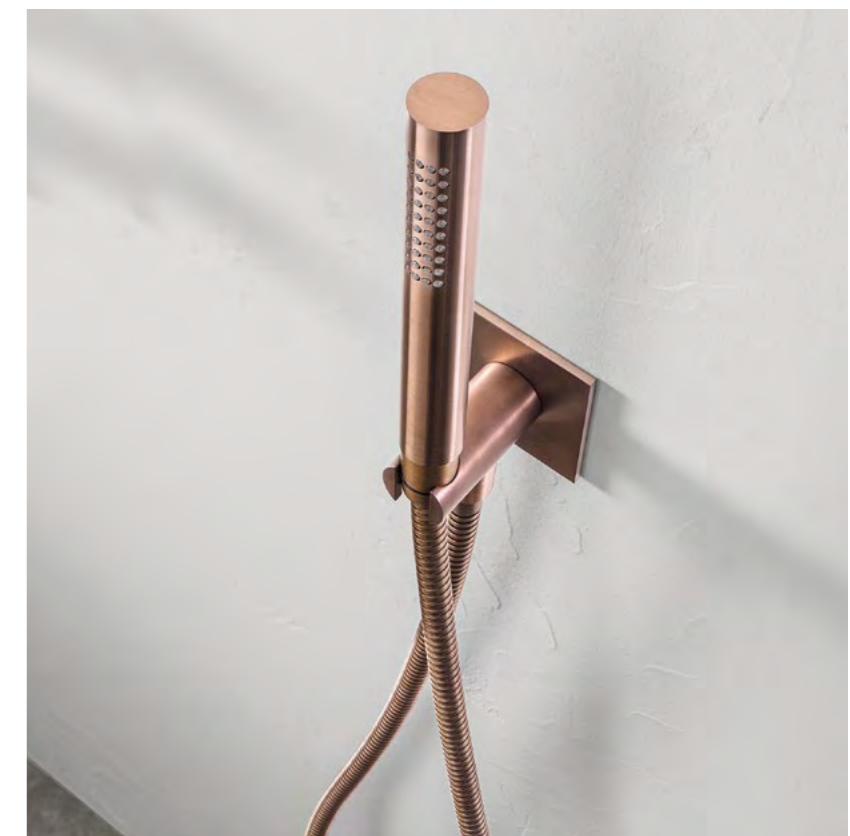

High Flow 2 vie con soffione Emotion tondo con doccia Easysteel - PVD High Brass

E044252 Soffione Emotion tondo Ø250mm · Emotion round shower head Ø250mm · Tête de douche Emotion ronde Ø250mm

E021093 Braccio doccia con canna curva 90° e rosone tondo L350mm · Shower arm with 90° curved tube and round flange L350mm · Bras de douche avec tube courbé à 90° et rosace ronde L350mm

E082095 Doccia Easysteel · Easysteel hand shower · Douchette Easysteel

E095032 Presa d'acqua con supporto tondo per doccia e rosone tondo · Water outlet with round hand shower support and round flange · Prise d'eau avec support rond pour douchette et rosace ronde

C084052 Flessibile in acciaio 316 L150cm · 316 stainless steel flexible hose L150cm · Flexible en acier inoxydable 316 L150cm

E180031 Estetica High Flow 2 vie con rosoni tondi e maniglie tonde · High Flow 2-way trim set with round rosettes and round handles · Façade High Flow 2 voies avec rosaces rondes et poignées rondes



Ottone
Brass
Laiton





Ottone | Brass | Laiton

PVD Copper

L'ottone rappresenta ancora oggi lo standard di riferimento per la rubinetteria e per i sistemi doccia, grazie alle sue caratteristiche tecniche e alla sua affidabilità nel tempo. L'evoluzione delle leghe di ottone e l'adeguamento continuo alle normative hanno portato allo sviluppo di materiali qualitativamente più evoluti e conformi ai requisiti di potabilità. Il trattamento con finiture PVD accresce le possibilità espressive dell'ottone, adattandosi a diverse esigenze progettuali e a differenti ambienti bagno. Un materiale versatile che unisce prestazioni consolidate, libertà estetica e compatibilità con il design contemporaneo.

Due to its technical properties and long-term reliability, brass remains one of the most widely used materials for the manufacture of taps and shower systems today. The evolution of brass alloys and ongoing compliance with regulations have led to the development of higher-quality materials that ensure the absolute purity and integrity

of drinking water. PVD finishes enhance the expressive potential of brass, adapting to a variety of design requirements and different bathroom spaces. A versatile material that combines proven performance, aesthetic freedom and compatibility with contemporary design.

Le laiton représente encore aujourd'hui le standard de référence pour la robinetterie et les systèmes de douche grâce à ses caractéristiques techniques et à sa fiabilité dans le temps. L'évolution des alliages de laiton et l'adaptation continue aux normes ont permis le développement de matériaux plus performants et conformes aux exigences de potabilité.

Les finitions PVD élargissent les possibilités expressives du laiton, en s'adaptant à différentes exigences de projet et à divers environnements de salle de bain. Un matériau polyvalent qui associe performances éprouvées, liberté esthétique et compatibilité avec le design contemporain.





E044306 Soffione Velvet tondo Ø300mm · Velvet round shower head Ø300mm · Tête de douche Velvet ronde Ø300mm

E021115 Braccio tondo curvo 90° con rosone tondo L420mm · Shower arm with 90° curved tube and round flange L420mm · Bras de douche avec tube courbé à 90° et rosace ronde L420mm

E180433 Estetica Modular Termostatico Push 2 vie con rosoni e maniglie tonde, completa di doccia Easysteel · Modular Thermostatic Push 2-way trim set with round rosettes and round handles, complete with Easysteel hand shower · Façade Modular Thermostatique Push 2 voies avec rosaces rondes et poignées rondes, complète avec douchette Easysteel

E082126 Doccia Stick Velvet · Stick Velvet hand shower · Douchette Stick Velvet

E300003 Mensola portasapone · Soap shelf · Étagère porte-savon



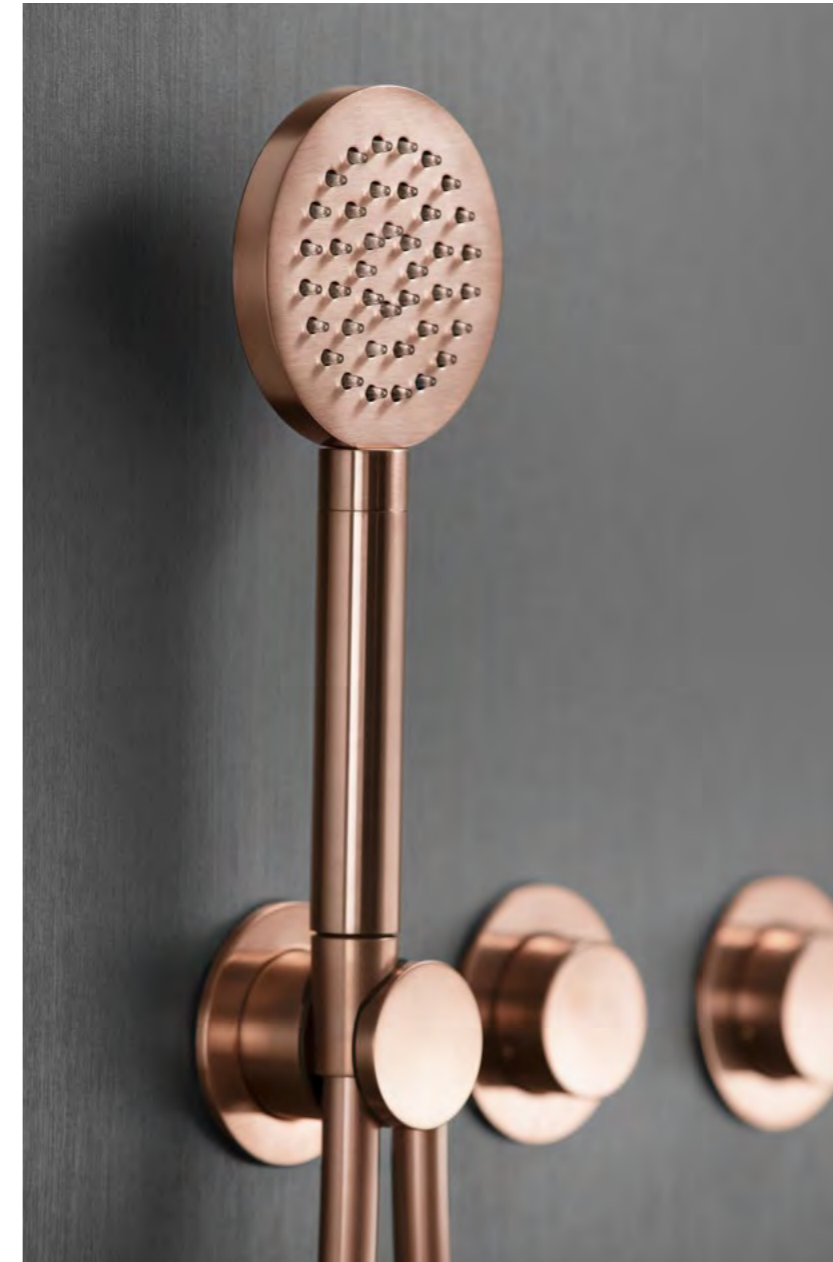

E044306 Soffione Velvet tondo Ø300mm ·
Velvet round shower head Ø300mm · Tête
de douche Velvet ronde Ø300mm

E082129 Doccia Posh · Posh hand shower
· Douchette Posh

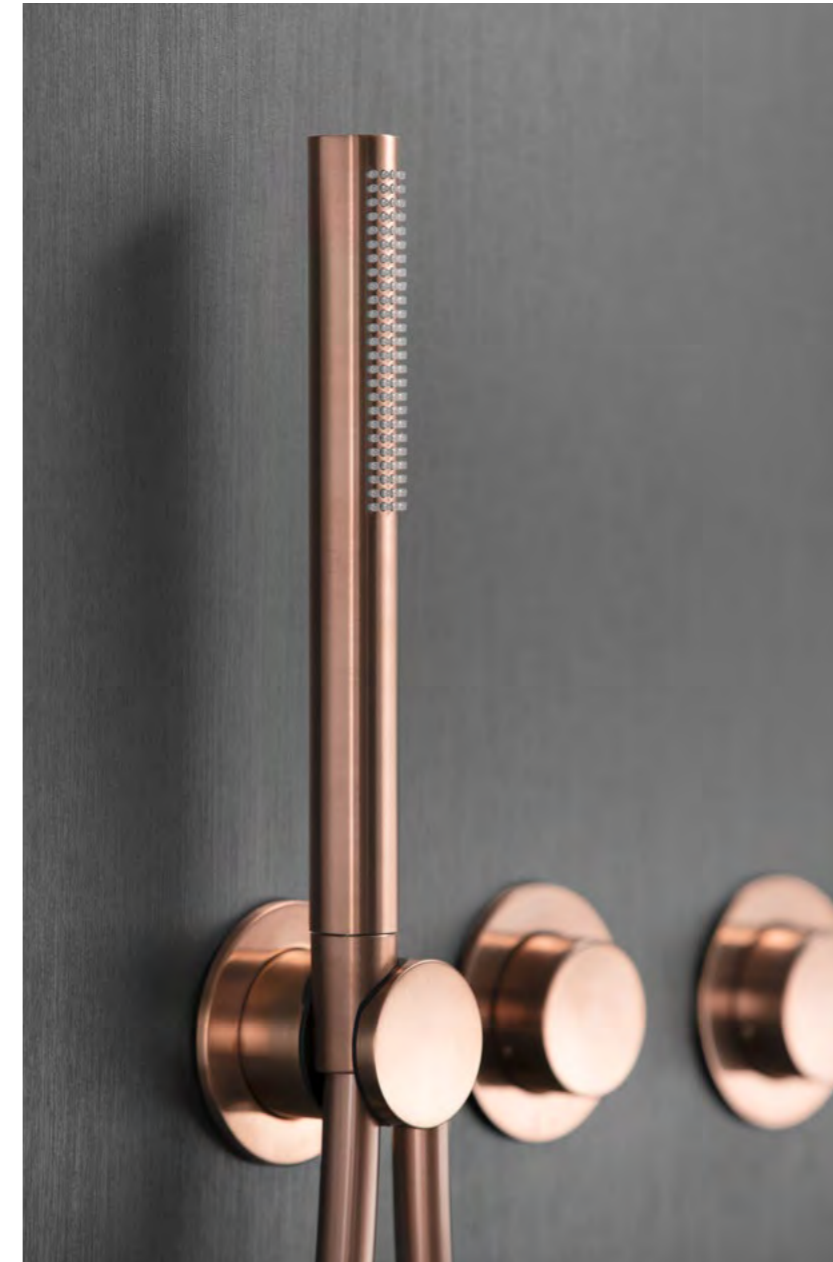

E044305 Soffione Velvet Light · Velvet
Light shower head · Tête de douche Velvet
Light

E082126 Doccia Stick Velvet · Stick Velvet
hand shower · Douchette Stick Velvet



E340001 Dispenser sapone liquido da parete · Wall-mounted liquid soap dispenser · Distributeur de savon liquide mural

E070001 Bicchieri portaspazzolino da parete · Wall-mounted toothbrush holder · Porte-brosses à dents mural

serie antes

E210057 Estetica miscelatore lavabo 3 fori a parete con canna lunga · Wall-mounted 3-hole basin faucet trim set with long spout · Mitigeur lavabo mural à 3 trous avec bec long

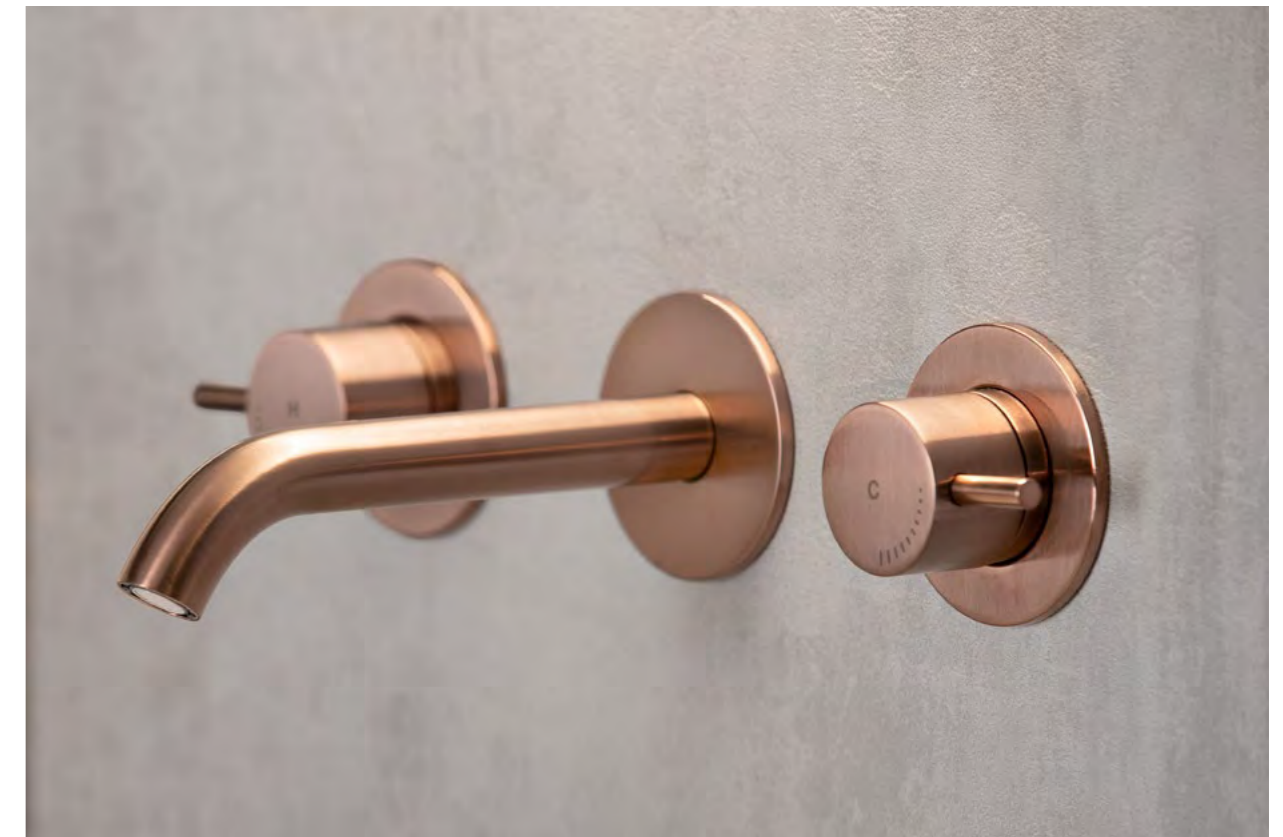

E340000 Dispenser sapone liquido da appoggio · Countertop liquid soap dispenser · Distributeur de savon liquide à poser

E070000 Bicchiera portaspazzolino da appoggio · Countertop toothbrush holder · Verre porte-brosses à dents à poser

E085003 Porta saponetta da parete · Wall-mounted soap dish · Porte-savonnette mural

serie antes

E214004 Miscelatore lavabo 3 fori da appoggio con canna curva · Deck-mounted 3-hole basin faucet with curved spout · Mitigeur lavabo 3 trous à poser avec bec courbe





E340000 Dispenser sapone liquido da appoggio · Countertop liquid soap dispenser · Distributeur de savon liquide à poser

E070000 Bicchieri portaspazzolino da appoggio · Countertop toothbrush holder · Verre porte-brosses à dents à poser

E305005 Porta asciugamano L450mm · Towel rail L450mm · Porte-serviettes L450mm

E085003 Porta saponetta da parete · Wall-mounted soap dish · Porte-savonnette mural

serie antes

E214007 Miscelatore monocomando lavabo freestanding · Freestanding single-lever basin faucet · Mitigeur lavabo monocommande sur pied





E400007 Termostatico esterno per vasca in acciaio inox 316L · Exposed thermostatic mixer for bathtub in 316L stainless steel · Thermostatique apparent pour baignoire en acier inoxydable 316L

E082126 Doccia Stick Velvet · Stick Velvet hand shower · Douchette Stick Velvet

E120012 Supporto tondo per doccia con rosone tondo · Round hand shower support with round flange · Support rond pour douchette avec rosace ronde

C084021 Flessibile in PVC in finitura L150cm · PVC flexible hose in matching finish L150cm · Flexible en PVC avec finition assortie L150cm

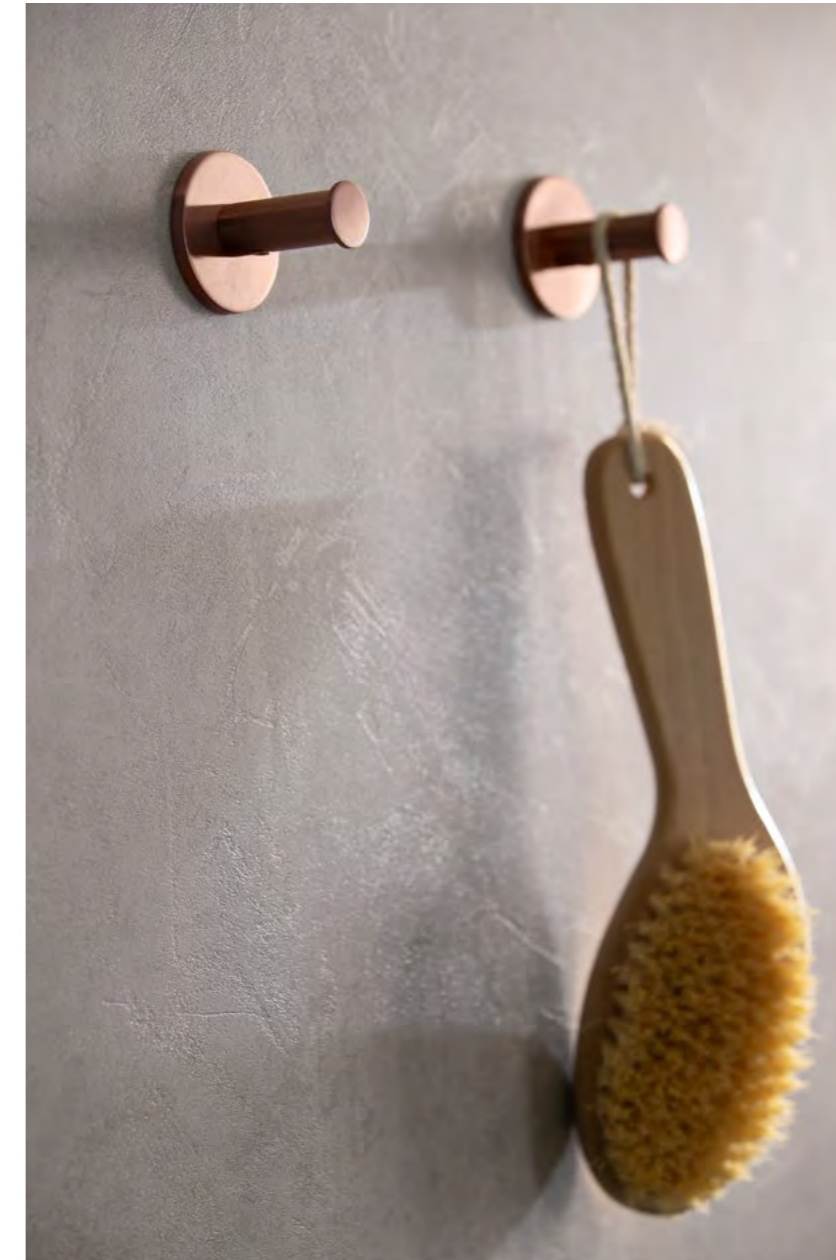

E310002 Porta accappatoio · Bathrobe hook · Porte-peignoir



E136010 Kit miscelatore WC con supporto e shut off Athena · WC mixer kit with support and Athena bidet hand shower · *Kit mitigeur WC avec support et douchette hygiénique Athena*

E330002 Placca WC con pulsanti tondi asimmetrici · WC flush plate with asymmetric round buttons · *Plaque WC avec boutons ronds asymétriques*

E315001 Porta rotolo destro · Right-hand toilet paper holder · *Porte-rouleau droit*

E068005 Porta scopino WC a parete · Wall-mounted toilet brush holder · *Porte-brosse WC mural*



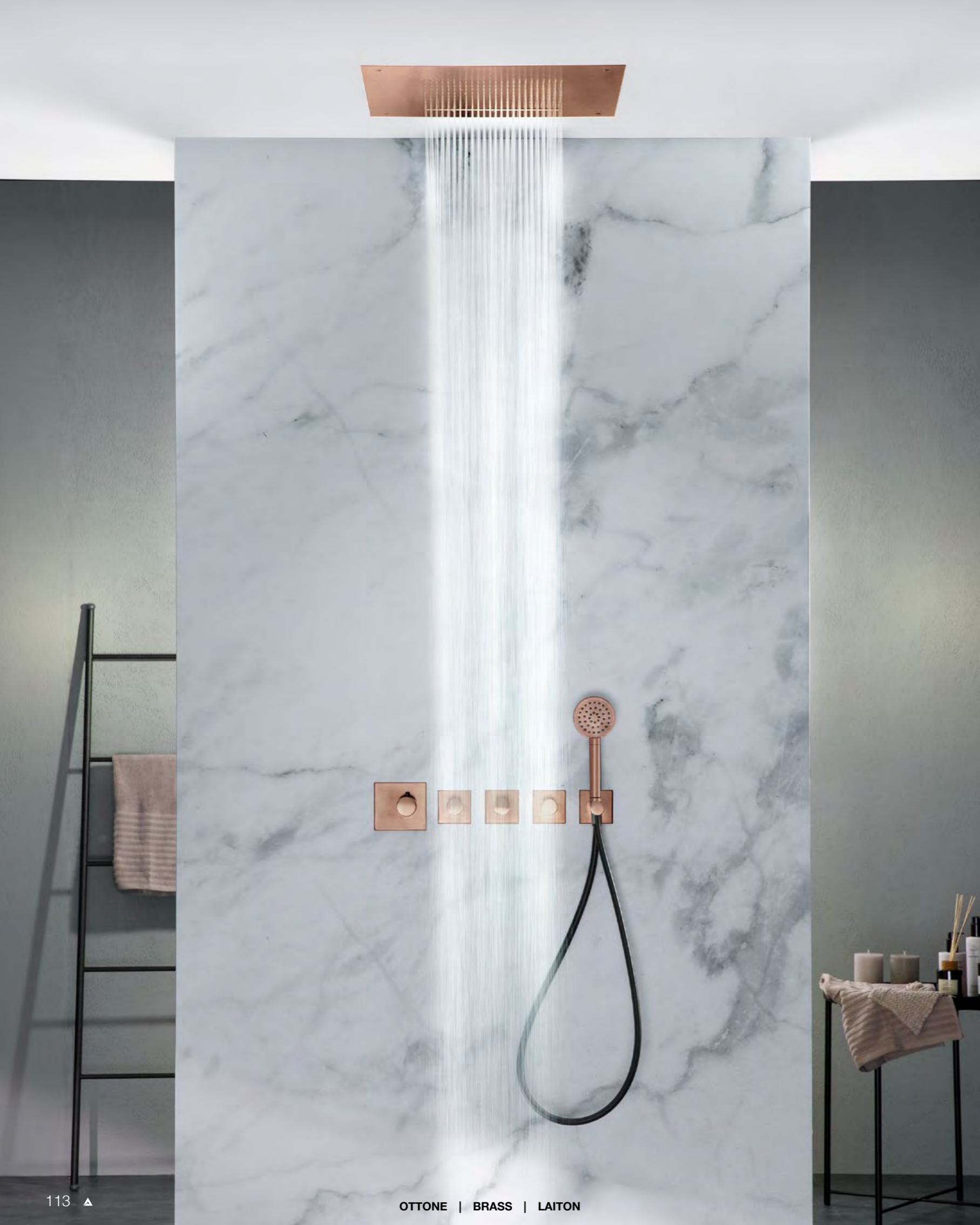

Ottone | Brass | Laiton

High Flow 3 vie con soffione Temptation a soffitto e doccia Posh - PVD Copper

E044280 Soffione Temptation Velvet
2 funzioni 500mm · Temptation Velvet
2-function shower head 500mm · Tête
de douche Temptation Velvet 2 fonctions
500mm

E180083 Estetica High Flow 3 vie con
rosioni quadri e maniglie tonde · High Flow
3-way trim set with square rosettes and
round handles · Façade High Flow 3 voies
avec rosaces carrées et poignées rondes

E082129 Doccia Posh · Posh hand shower
· Douchette Posh

E095039 Presa d'acqua con supporto
tondo per doccia e rosone quadro · Water
outlet with round hand shower support and
square rosette · Prise d'eau avec support
rond pour douchette et rosace carrée

C084043 Flessibile in PVC nero con coni
in finitura L150cm · Black PVC flexible hose
with finished cones L150cm · Flexible en
PVC noir avec cônes finition L150cm

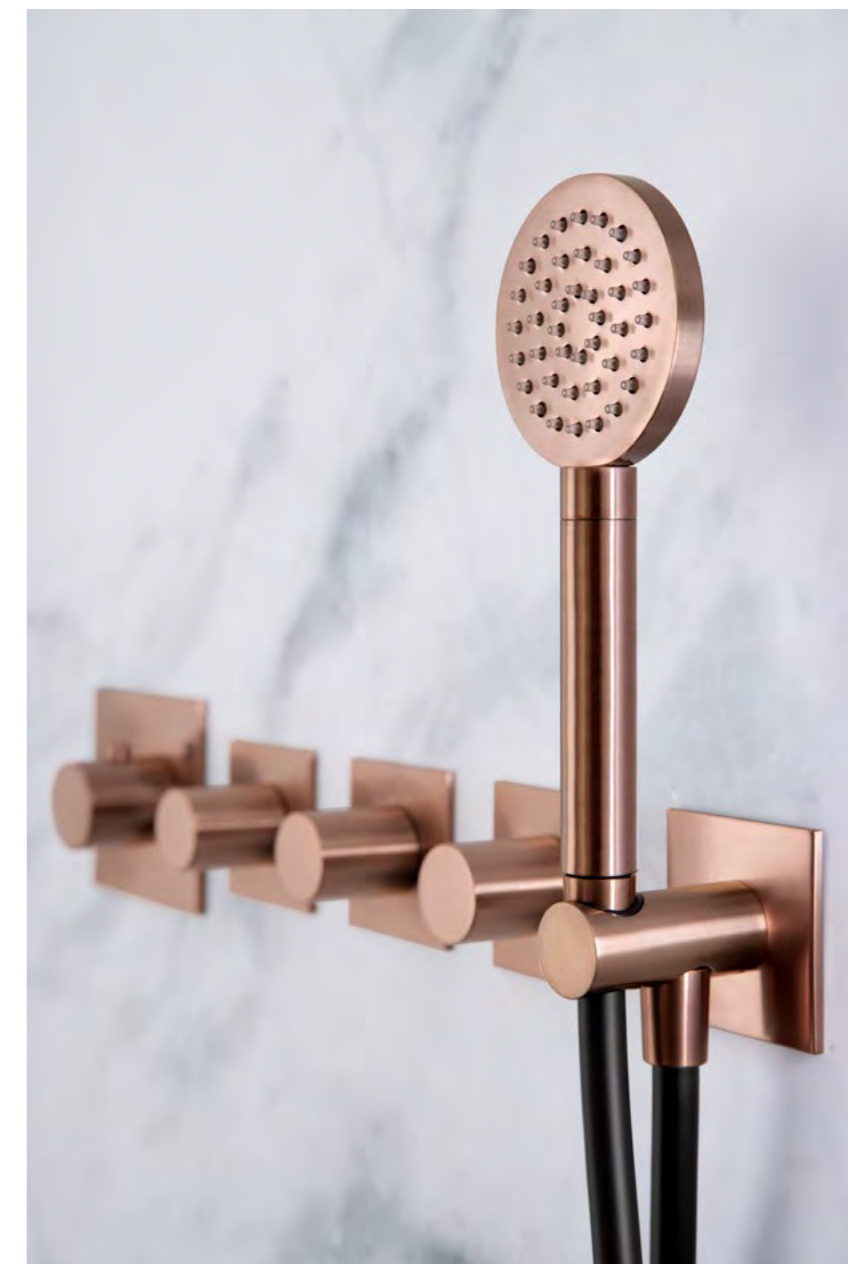

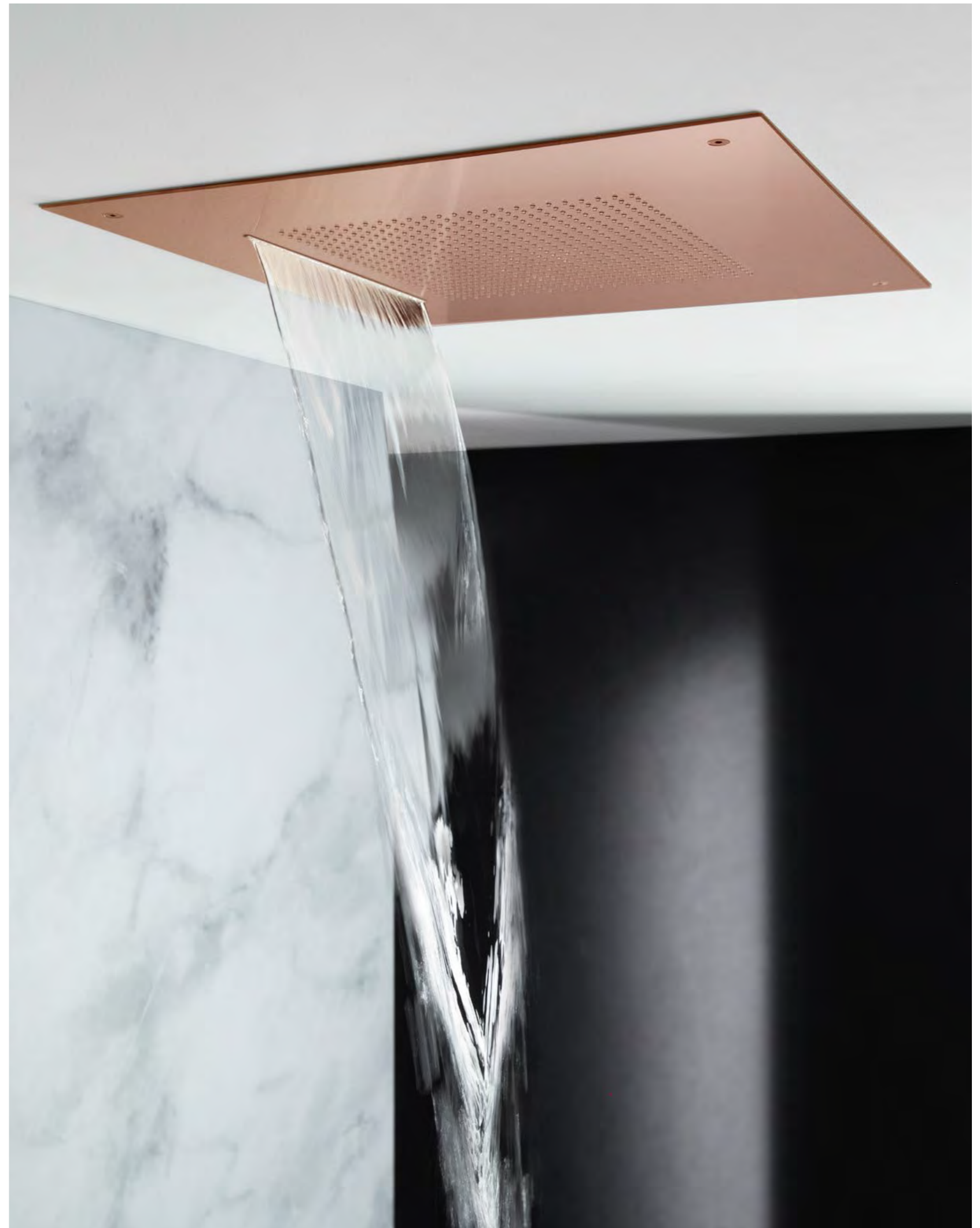



Ottone | Brass | Laiton

Modular Push 2 vie con soffione Sway e doccia Stick Velvet - PVD High Brass

La colorazione oro spazzolato della finitura high brass si distingue con decisione sulle superfici scure, garantendo continuità visiva tra le diverse funzioni e rafforzando la lettura di un sistema coordinato che attraversa l'intero ambiente bagno.

La parete doccia diventa l'elemento centrale del progetto, con il soffione Sway abbinato al comando Modular Push, mentre la stessa finitura high brass prosegue sulla rubinetteria lavabo e bidet della serie Antes e sulla placca WC con tasti rettangolari.

La teinte or brossé de la finition high brass se distingue nettement sur les surfaces foncées, garantissant une continuité visuelle entre les différentes fonctions et renforçant la perception d'un système coordonné qui traverse l'ensemble de la salle de bain.

La paroi de douche devient l'élément central du projet, avec la tête de douche Sway associé au commande Modular Push, tandis que la même finition high brass se prolonge sur la robinetterie lavabo et bidet de la série Antes et sur la plaque WC à boutons rectangulaires.

The brushed gold tone of the High Brass finish stands out boldly against dark surfaces, ensuring visual continuity across different functions and reinforcing the concept of a coordinated bathroom system.

The shower wall becomes the project's main point, featuring the Sway showerhead paired with the Modular Push control. This High Brass finish extends across the Antes collection for the basin and bidet faucets, as well as the toilet flush plate with its rectangular buttons.



E044301 Soffione Sway tondo · Sway round shower head · Tête de douche Sway ronde



E180433 Estetica Modular Termostatico Push 2 vie con rosoni e maniglie tonde, completa di doccia Easysteel · Modular Thermostatic Push 2-way trim set with round rosettes and round handles, complete with Easysteel hand shower · Façade Modular Thermostatique Push 2 voies avec rosaces rondes et poignées rondes, complète avec douchette Easysteel

E082126 Doccia Stick Velvet · Stick Velvet hand shower · Douchette Stick Velvet



E330001 Placca WC con pulsanti rettangolari · WC flush plate with rectangular buttons · Plaque WC avec boutons rectangulaires

E315000 Porta rotolo · Toilet paper holder · Porte-rouleau

serie antes

E214000 Miscelatore monocomando lavabo · Single-lever washbasin faucet · Mitigeur monocommande lavabo

serie antes

E214003 Miscelatore monocomando bidet · Single-lever bidet faucet · Mitigeur monocommande bidet



Saliscendi con doccia Posh - PVD High Brass

E087075 Saliscendi Flexi con rosoni tondi L1000mm · Flexi slide bar with round rosettes L1000mm · Barre de douche Flexi avec rosaces rondes L1000mm

E180140 Estetica Modular Meccanico 1 via con rosone tondo · Modular Mechanical 1-way trim set with round rosette · Façade Modular Mécanique 1 voie avec rosace ronde

E095040 Presa d'acqua tonda con rosone tondo · Round water outlet with round rosette · Prise d'eau ronde avec rosace ronde

E082129 Doccia Posh · Posh hand shower · Douchette Posh

C084043 Flessibile in PVC nero con coni in finitura L150cm · Black PVC flexible hose with finished cones L150cm · Flexible en PVC noir avec cônes finition L150cm

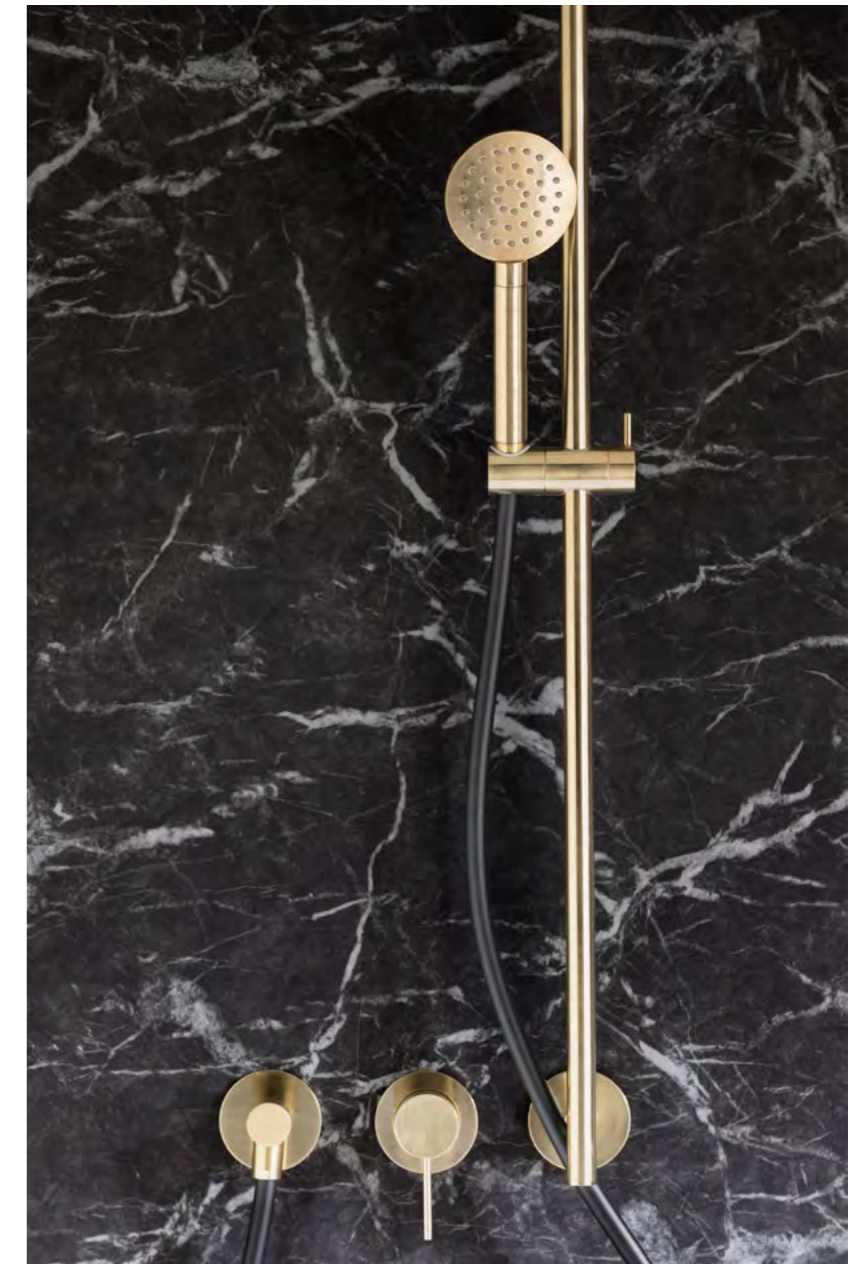



E180136 Estetica Modular Termostatico 2 vie bordo vasca con rosoni e maniglie tonde e bocca curva, completa di doccia Easysteel · Modular Thermostatic 2-way deck-mounted bathtub trim set with round rosettes, round handles and curved spout, complete with Easysteel hand shower · *Façade Modular Thermostatique 2 voies bord de baignoire avec rosaces rondes, poignées rondes et bec courbé, complète avec douchette Easysteel*

E082091 Doccia Easybrass · Easybrass hand shower · *Douchette Easybrass*

Core push 3 vie con soffione Temptation e doccia Posh - PVD High Brass

E044024 Soffione Temptation quadro monogetto 500mm · Temptation square single-jet shower head 500mm · Tête de douche Temptation carrée monojet 500mm

E003194 Estetica cascata XL a incasso · XL built-in waterfall trim set · Façade cascade XL encastrable

E176683 Estetica Core Termostatico Push 3 vie rettangolare con maniglie tonde · Core Thermostatic Push rectangular 3-way trim set with round handles · Façade Core Thermostatique Push rectangulaire 3 voies avec poignées rondes

E082129 Doccia Posh · Posh hand shower · Douchette Posh

E095039 Presa d'acqua con supporto quadro per doccia e rosone quadro · Water outlet with square hand shower support and square rosette · Prise d'eau avec support rond pour douchette et rosace carrée

C084043 Flessibile in PVC nero con coni in finitura L150cm · Black PVC flexible hose with finished cones L150cm · Flexible en PVC noir avec cônes finition L150cm carrée

E300001 Mensola portasapone · Soap shelf · Étagère porte-savon

E310001 Porta accappatoio · Bathrobe hook · Porte-peignoir





Ottone | Brass | Laiton

Core 3 vie con soffione Temptation e doccia Sense Massage - PVD Gold

Un ambiente doccia luminoso e aperto, in cui la finitura oro lucido introduce una nota calda e luminosa, contribuendo a creare un'atmosfera rilassante e immersiva che si integra in modo equilibrato nell'architettura.

Il sistema doccia con soffione Temptation a soffitto, doccia Sense multifunzione e getti a parete è gestito da un comando termostatico Core che coordina le diverse funzioni.

Un environnement de douche lumineux et ouvert où la finition or poli introduit une note chaude et lumineuse, contribuant à créer une atmosphère relaxante et immersive qui s'intègre harmonieusement dans l'architecture.

Le système de douche avec tête de douche Temptation à plafond, douchette Sense multifonction et jets muraux est géré par une commande thermostatique Core qui coordonne les différentes fonctions.

A bright, open shower space. A polished gold finish that adds a warm, luminous touch to create a relaxing and immersive atmosphere blending discreetly into the architectural setting. The shower system, featuring the ceiling-mounted Temptation showerhead, the multi-function Sense hand shower, and wall-mounted jets, is powered by a Core thermostatic control that coordinates the various functions.



E044024 Soffione Temptation quadro monogetto 500mm · Temptation square single-jet shower head 500mm · Tête de douche Temptation carrée monojet 500mm

E176823 Estetica Core Termostatico 3 vie rettangolare con maniglie quadre · Core Thermostatic 3-way rectangular trim set with square handles · Façade Core Thermostatique 3 voies rectangulaire avec poignées carrées

E082135 Doccia Sense Massage multigetto · Sense Massage multi-jet hand shower · Douchette Sense Massage multijet

E095039 Presa d'acqua con supporto tondo per doccia e rosone quadro · Water outlet with round hand shower support and square rosette · Prise d'eau avec support rond pour douchette et rosace carrée

C084052 Flessibile in acciaio 316 L150cm · 316 stainless steel flexible hose L150cm · Flexible en acier inoxydable 316 L150cm

E300001 Mensola portasapone · Soap shelf · Étagère porte-savon

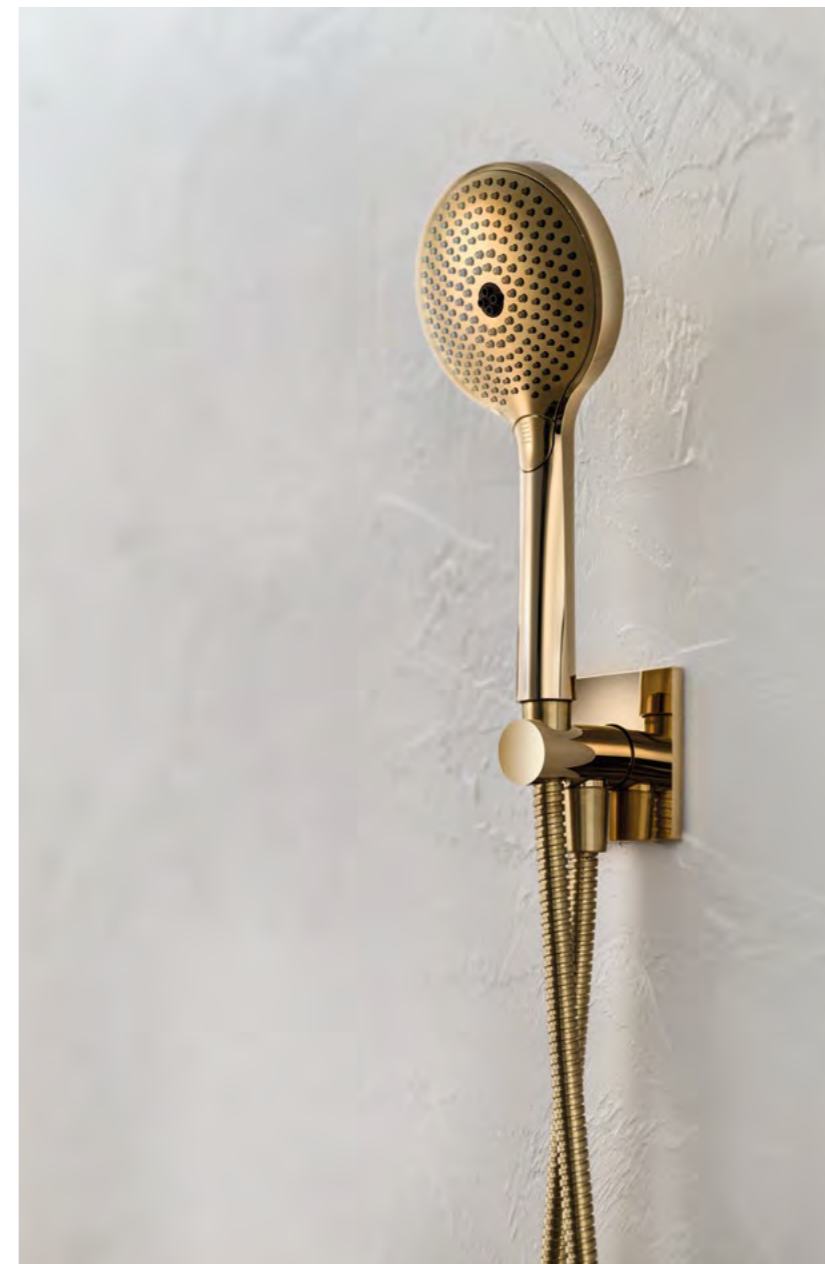



E310001 Porta accappatoio · Bathrobe
hook · Porte-peignoir



E044261 Bodyjet Mist quadro · Square
Mist body jet · Jet massant Mist carré



Ottone | Brass | Laiton

High Flow 3 vie con soffione Temptation e doccia Easybrass - PVD Deep Black

E044216 Soffione Temptation Cascade quadro 2 funzioni 380mm · Temptation Cascade square shower head 2 functions 380mm · Tête de douche Temptation Cascade carrée 2 fonctions 380mm

E180083 Estetica High Flow 3 vie con rosoni quadri e maniglie tonde · High Flow 3-way trim set with square rosettes and round handles · Façade High Flow 3 voies avec rosaces carrées et poignées rondes

E082091 Doccia Easybrass · Easybrass hand shower · Douchette Easybrass

E095039 Presa d'acqua con supporto tondo per doccia e rosone quadro · Water outlet with round hand shower support and square rosette · Prise d'eau avec support rond pour douchette et rosace carrée

C084052 Flessibile in acciaio 316 L150cm · 316 stainless steel flexible hose L150cm · Flexible en acier inoxydable 316 L150cm

E305001 Porta asciugamani L450mm · Towel rail L450mm · Porte-serviettes L450mm





Modular 3 vie quadro con soffione Temptation e doccia Easybrass - Matt Black

E044282 Soffione Temptation Velvet quadro a 2 funzioni 380mm · Temptation Velvet square shower head with 2 functions 380mm · Tête de douche Temptation Velvet carrée à 2 fonctions 380mm

E180183 Estetica Modular Termostatico 3 vie con rosoni quadri e maniglie tonde, completa di doccia Easybrass · Modular Thermostatic 3-way trim set with square rosettes and round handles, complete with Easybrass hand shower · Façade Modular Thermostatique 3 voies avec rosaces carrées et poignées rondes, complète avec douche Easybrass

E082091 Doccia Easybrass · Easybrass hand shower · Douche Easybrass



High Flow 2 vie tondo con soffione Emotion e doccia Sense Icicle - Matt Black

E044044 Soffione Emotion tondo
Ø300mm · Emotion round shower head
Ø300mm · Tête de douche Emotion ronde
Ø300mm

E021113 Braccio doccia con canna curva
90° e rosone tondo L350mm · Shower
arm with 90° curved tube and round flange
L350mm · Bras de douche avec tube courbé
à 90° et rosace ronde L350mm

E082134 Doccia Sense Icicle multigetto
· Sense Icicle multi-jet hand shower ·
Douchette Sense Icicle multijet

E095037 Presa d'acqua con supporto
tondo per doccia e rosone tondo · Water
outlet with round holder for hand shower
and round rosette · Prise d'eau avec support
rond pour douchette et rosace ronde

C084043 Flessibile in PVC nero con coni
in finitura L150cm · Black PVC flexible hose
with finished cones L150cm · Flexible en
PVC noir avec cônes finition L150cm

E180031 Estetica High Flow 2 vie con
rosone tondi e maniglie tonde · High Flow
2-way trim set with round rosettes and
round handles · Façade High Flow 2 voies
avec rosaces rondes et poignées rondes

E300001 Mensola portasapone · Soap
shelf · Étagère porte-savon

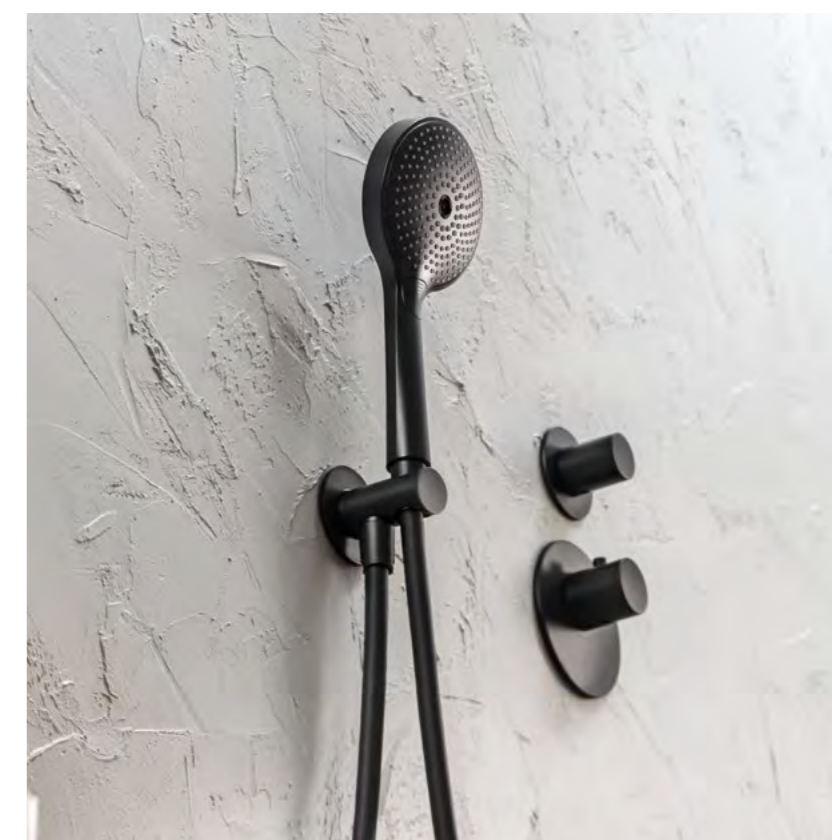



Ottone | Brass | Laiton

Core meccanico 3 vie con soffione Emotion e doccia Emotion - Matt Black

E044039 Soffione Emotion quadro 300mm
· Emotion square shower head 300mm ·
Tête de douche Emotion carrée 300mm

E021108 Braccio doccia a soffitto con
rosone quadro L300mm · Ceiling shower
arm with square flange L300mm · Bras de
douche plafond avec rosace carrée L300mm

E044086 Cascata esterna a parete · Wall-
mounted external waterfall · Cascade murale
apparente

E186543 Estetica Core Meccanico 3 vie
rettangolare con maniglia Thin · Core
Mechanical 3-way rectangular trim set with
Thin handle · Façade Core Mécanique 3
voies rectangulaire avec poignée Thin

E082027 Doccia Emotion Ø100mm
monogetto · Emotion hand shower
Ø100mm single jet · Douchette Emotion
Ø100mm monojet

E095039 Presa d'acqua con supporto
tondo per doccia e rosone quadro · Water
outlet with round hand shower support and
square rosette · Prise d'eau avec support
rond pour douchette et rosace carrée

C084043 Flessibile in PVC nero con coni
in finitura L150cm · Black PVC flexible hose
with finished cones L150cm · Flexible en
PVC noir avec cônes finition L150cm



Core termostatico 2 vie con soffione Emotion e doccia Sense Massage - Matt White

E044049 Soffione Emotion tondo Ø250mm · Emotion round shower head Ø250mm · Tête de douche Emotion ronde Ø250mm

E021109 Braccio doccia a soffitto con rosone tondo L300mm · Ceiling shower arm with round flange L300mm · Bras de douche plafond avec rosace ronde L300mm

E082135 Doccia Sense Massage multigetto · Sense Massage multi-jet hand shower · Douchette Sense Massage multijet

E095037 Presa d'acqua con supporto tondo per doccia e rosone tondo · Water outlet with round holder for hand shower and round rosette · Prise d'eau avec support rond pour douchette et rosace ronde

C084021 Flessibile in PVC in finitura L150cm · PVC flexible hose in matching finish L150cm · Flexible en PVC avec finition assortie L150cm

E176832 Estetica Core Termostatico 2 vie tonda con maniglie tonde · Core Thermostatic 2-way round trim set with round handles · Façade Core Thermostatique 2 voies ronde avec poignées rondes

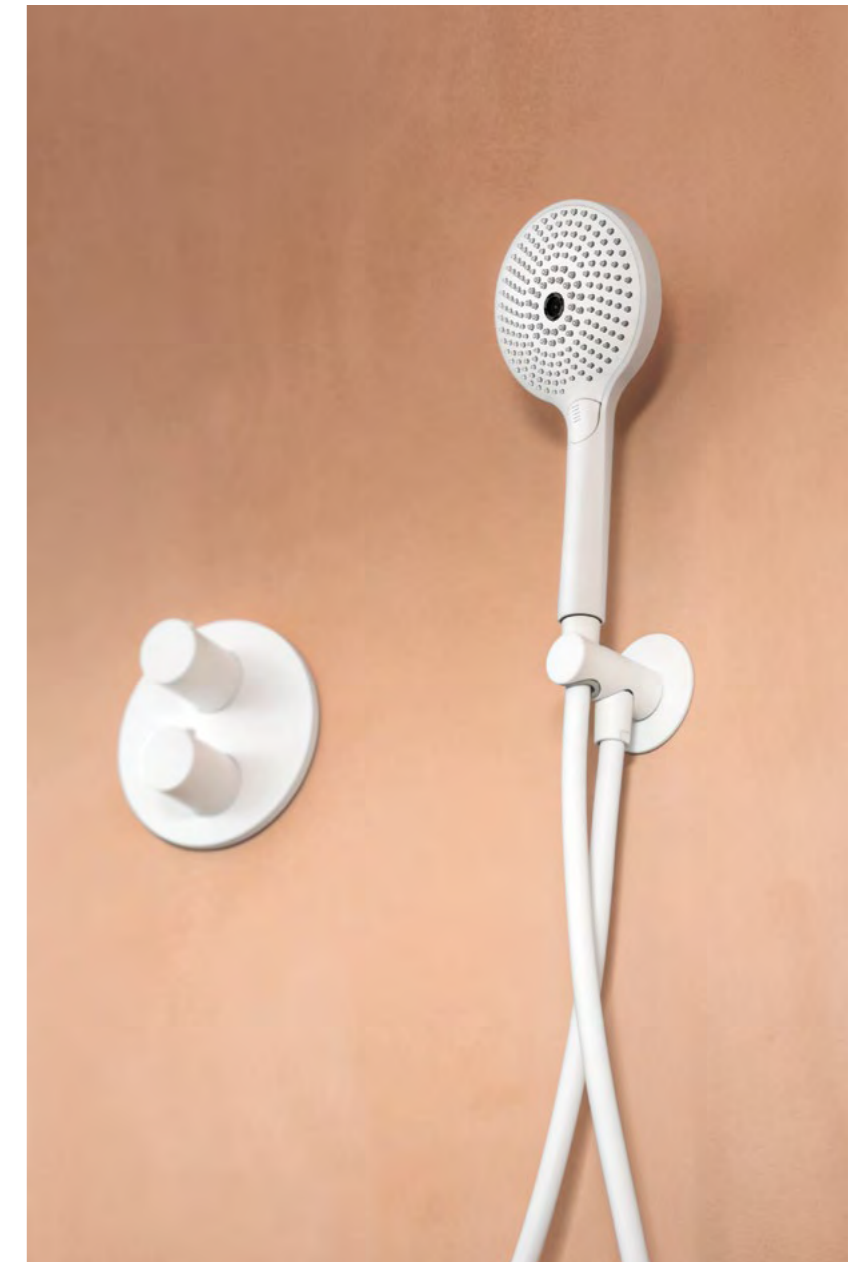



Acciaio e Cromo | Steel and Chrome | Acier et Chrome

High Flow 2 vie con soffione Temptation e doccia Easybrass - Chrome

E044279 Soffione Temptation Velvet quadro monogetto 380mm · Temptation Velvet square single-jet shower head 380mm · Tête de douche Temptation Velvet carrée monojet 380mm

E180082 Estetica High Flow 2 vie con rosoni quadri e maniglie tonde · High Flow 2-way trim set with square rosettes and round handles · Façade High Flow 2 voies avec rosaces carrées et poignées rondes

E082091 Doccia Easybrass · Easybrass hand shower · Douchette Easybrass

E095039 Presa d'acqua con supporto tondo per doccia e rosone quadro · Water outlet with round hand shower support and square rosette · Prise d'eau avec support rond pour douchette et rosace carrée

C084021 Flessibile in PVC in finitura L150cm · PVC flexible hose in matching finish L150cm · Flexible en PVC avec finition assortie L150cm

E310001 Porta accappatoio · Bathrobe hook · Porte-peignoir



Modular termostatico 2 vie con soffione Beam e doccia Easybrass - Chrome

E044286 Soffione Beam multigetto da parete · Wall-mounted Beam multi-jet shower head · *Tête de douche Beam multijet murale*

E180133 Estetica Modular Termostatico 2 vie con rosoni e maniglie tonde, completa di doccia Easybrass · Modular Thermostatic 2-way trim set with round rosettes and round handles, complete with Easybrass hand shower · *Façade Modular Thermostatique 2 voies avec rosaces rondes et poignées rondes, complète avec douchette Easybrass*

E082091 Doccia Easybrass · Easybrass hand shower · *Douchette Easybrass*

E300001 Mensola portasapone · Soap shelf · *Étagère porte-savon*

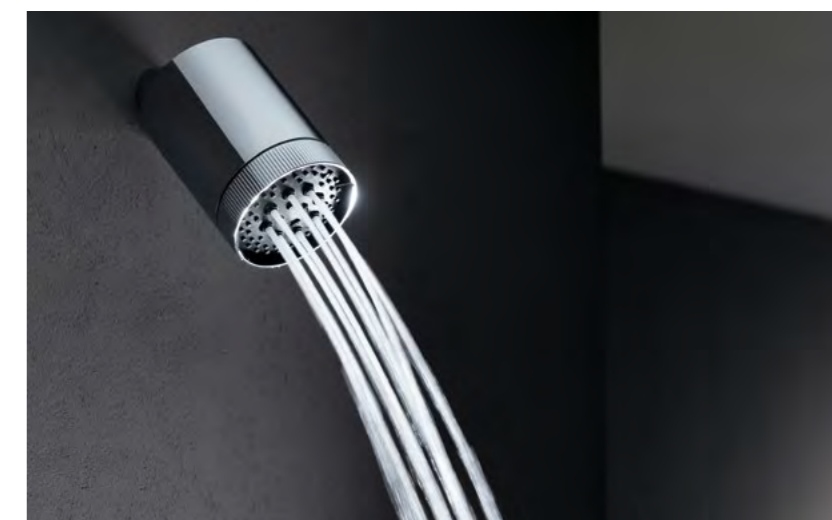

High Flow 5 vie con soffione Temotion e doccia Thin - Chrome

E044302 Soffione Temotion Icicle quadro a 3 funzioni con cromoterapia · Square Temotion Icicle shower head with 3 functions and chromotherapy · Tête de douche Temotion Icicle carrée à 3 fonctions avec chromothérapie

E044177 Bodyjet Spin quadro · Square Spin body jet · Jet massant Spin carré

E180025 Estetica High Flow 5 vie con rosoni quadri e maniglie quadre · High Flow 5-way trim set with square rosettes and square handles · Façade High Flow 5 voies avec rosaces carrées et poignées carrées

E082094 Doccia Thin · Thin hand shower · Douchette Thin

E095010 Presa d'acqua con supporto quadro per doccia e rosone quadro · Water outlet with square hand shower support and square rosette · Prise d'eau avec support carré pour douchette et rosace carrée

C084023 Flessibile in PVC cromato L150cm · PVC flexible hose with chrome finish L150cm · Flexible en PVC chromé L150cm

E300001 Mensola portasapone · Soap shelf · Étagère porte-savon

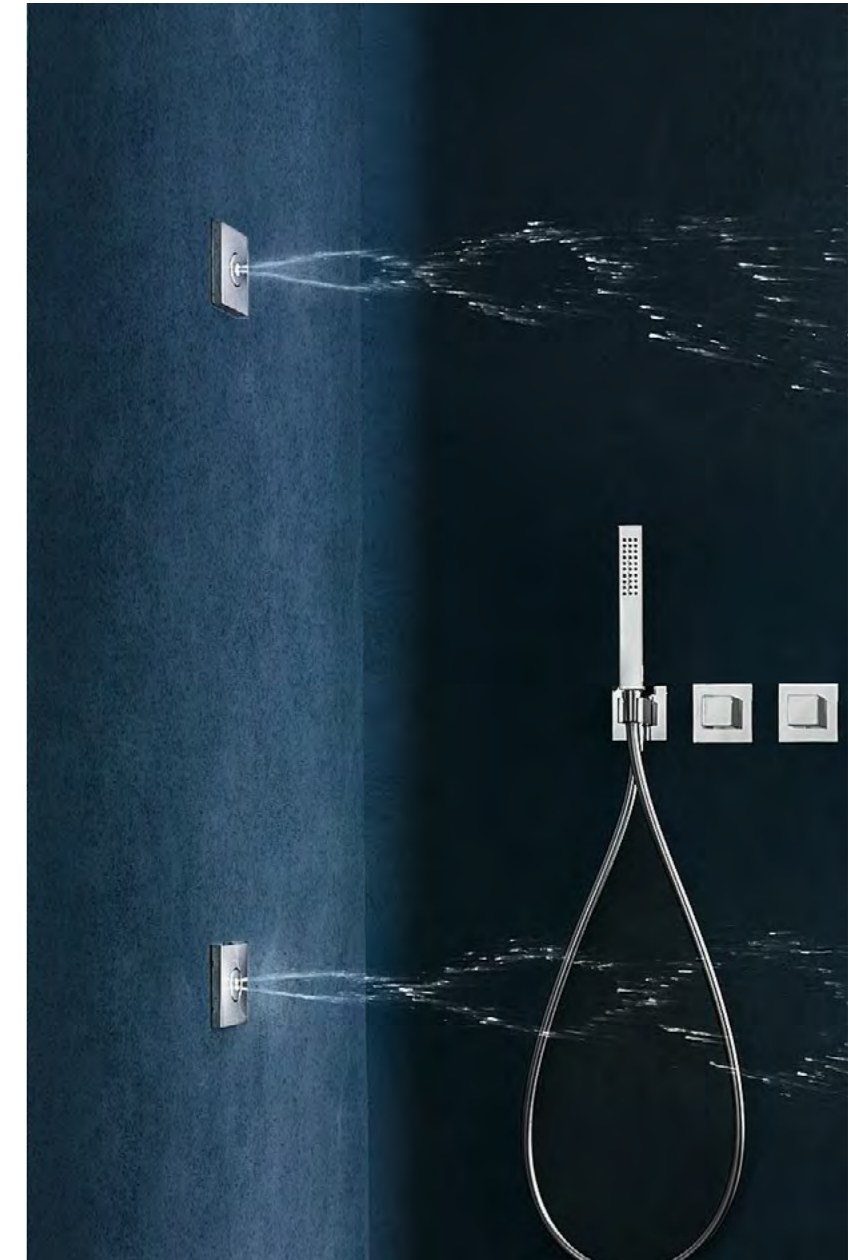



Core 3 vie con soffione Temptation e doccia Sense Iccicle - Chrome

E044258 Soffione Temptation Iccicle quadro a 2 funzioni · Square Temptation Iccicle shower head with 2 functions · Tête de douche Temptation Iccicle carrée à 2 fonctions

E186543 Estetica Core Meccanico 3 vie rettangolare con maniglia Thin · Core Mechanical 3-way rectangular trim set with Thin handle · Façade Core Mécanique 3 voies rectangulaire avec poignée Thin

E082136 Doccia Sense Iccicle multigetto con erogatore nero · Sense Iccicle multi-jet hand shower with black diffuser · Douchette Sense Iccicle multijet avec diffuseur noir

E095039 Presa d'acqua con supporto tondo per doccia e rosone quadro · Water outlet with round hand shower support and square rosette · Prise d'eau avec support rond pour douchette et rosace carrée

C084023 Flessibile in PVC cromato L150cm · PVC flexible hose with chrome finish L150cm · Flexible en PVC chromé L150cm

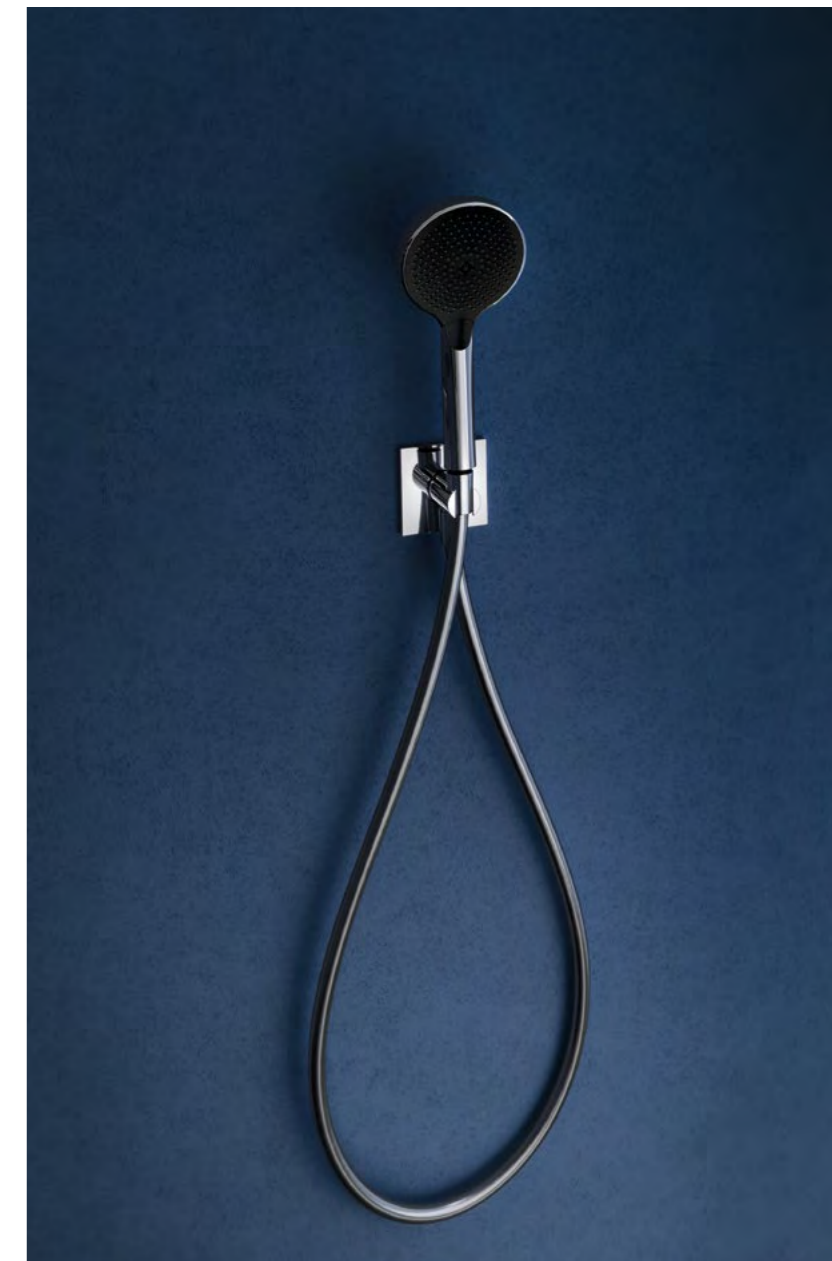



Core Push 2 vie con cascata e doccia Sense Massage - Chrome



E044273 Cascata XL esterna a parete
· Wall-mounted XL external waterfall ·
Cascade XL murale apparente

E176682 Estetica Core Termostatico Push
2 vie rettangolare con maniglie tonde
· Core Push Thermostatic rectangular
2-way trim set with round handles ·
*Façade thermostatique Core Push rectangulaire 2
voies avec poignées rondes*

E082135 Doccia Sense multigetto con
getto Massage · Sense multi-jet hand
shower with Massage spray ·
Douchette Sense multijet avec jet Massage

E095039 Presa d'acqua con supporto
tondo per doccia e rosone quadro · Water
outlet with round hand shower support and
square rosette ·
*Prise d'eau avec support
rond pour douchette et rosace carrée*

C084023 Flessibile in PVC cromato
L150cm · PVC flexible hose with chrome
finish L150cm ·
*Flexible en PVC chromé
L150cm*

E300001 Mensola portasapone · Soap
shelf ·
Étagère porte-savon



High Flow 4 vie con soffione Smart e doccia Thin - Chrome

E044199 Soffione Smart 2 funzioni · Smart 2-function shower head · Tête de douche Smart à 2 fonctions

E044177 Bodyjet Spin quadro · Square Spin body jet · Jet massant Spin carré

E180022 Estetica High Flow 4 vie con rosoni quadri e maniglie quadre · High Flow 4-way trim set with square rosettes and square handles · Façade High Flow 4 voies avec rosaces carrées et poignées carrées

E082070 Doccia Thin · Thin hand shower · Douchette Thin

E095010 Presa d'acqua con supporto quadro per doccia e rosone quadro · Water outlet with square hand shower support and square rosette · Prise d'eau avec support carré pour douchette et rosace carrée

C084021 Flessibile in PVC in finitura L150cm · PVC flexible hose in matching finish L150cm · Flexible en PVC avec finition assortie L150cm



High Flow 5 vie con soffione Temptation e doccia Thin - Chrome

E044190 Soffione Temptation rettangolare a 3 funzioni con cromoterapia 630x480mm · Temptation rectangular shower head with 3 functions and chromotherapy 630x480mm · Tête de douche Temptation rectangulaire à 3 fonctions avec chromothérapie 630x480mm

E180085 Estetica High Flow 5 vie con rosoni quadri e maniglie tonde · High Flow 5-way trim set with square rosettes and round handles · Façade High Flow 5 voies avec rosaces carrées et poignées rondes

E044177 Bodyjet Spin quadro · Square Spin body jet · Jet massant Spin carré

E082070 Doccia Thin · Thin hand shower · Douchette Thin

E095010 Presa d'acqua con supporto quadro per doccia e rosone quadro · Water outlet with square hand shower support and square rosette · Prise d'eau avec support carré pour douchette et rosace carrée

C084023 Flessibile in PVC cromato L150cm · PVC flexible hose with chrome finish L150cm · Flexible en PVC chromé L150cm

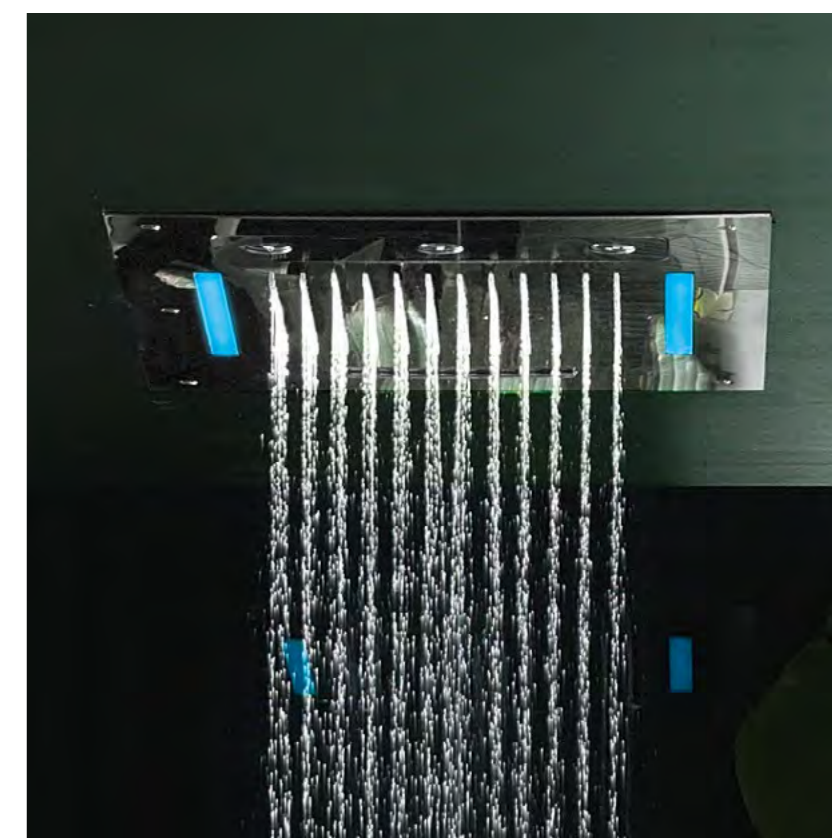

High Flow 5 vie con soffione Temptation 950 e doccia Thin - Chrome

E044173 Soffione Temptation quadro a 4 funzioni con cromoterapia 950mm · Temptation square shower head with 4 functions and chromotherapy 950mm · Tête de douche Temptation carrée à 4 fonctions avec chromothérapie 950mm

E180025 Estetica High Flow 5 vie con rosoni quadri e maniglie quadre · High Flow 5-way trim set with square rosettes and square handles · Façade High Flow 5 voies avec rosaces carrées et poignées carrées

E082070 Doccia Thin · Thin hand shower · Douchette Thin

E095010 Presa d'acqua con supporto quadro per doccia e rosone quadro · Water outlet with square hand shower support and square rosette · Prise d'eau avec support carré pour douchette et rosace carrée

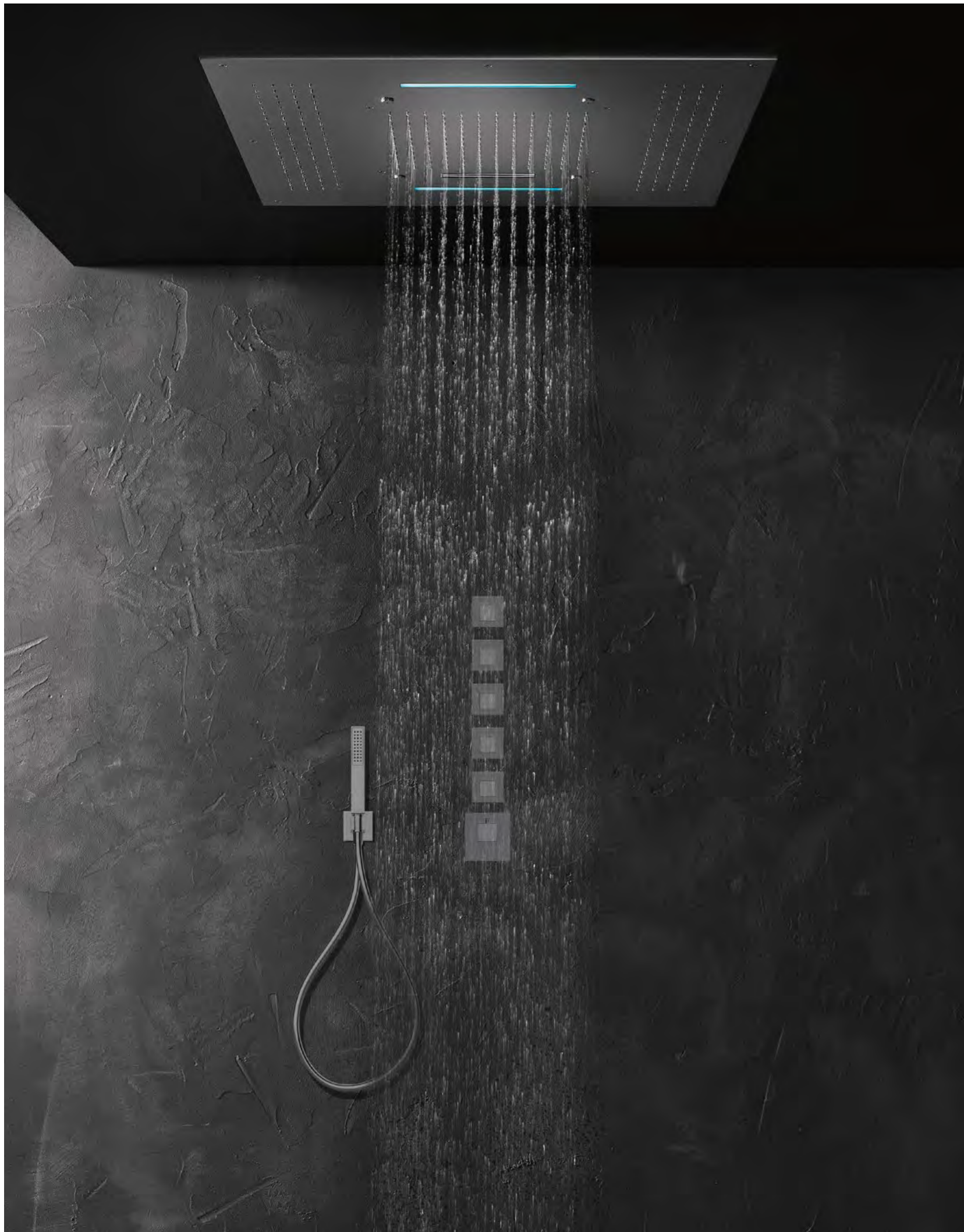
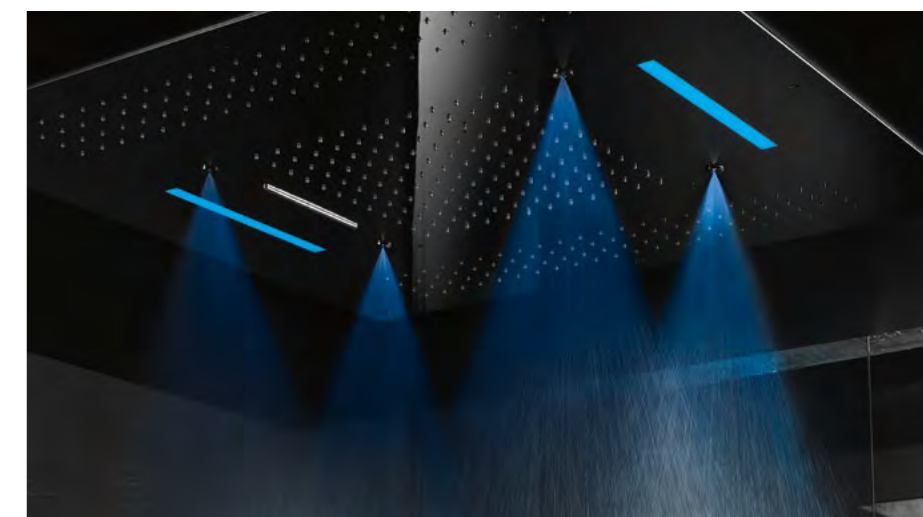
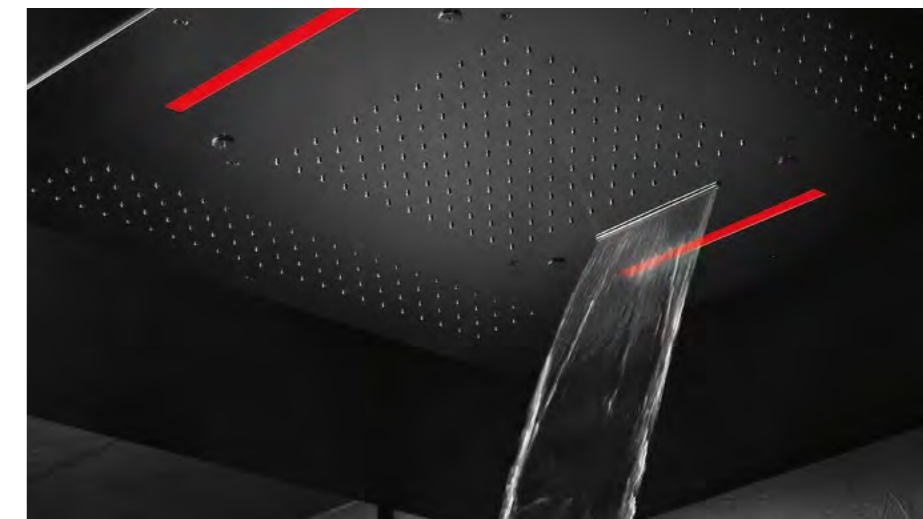
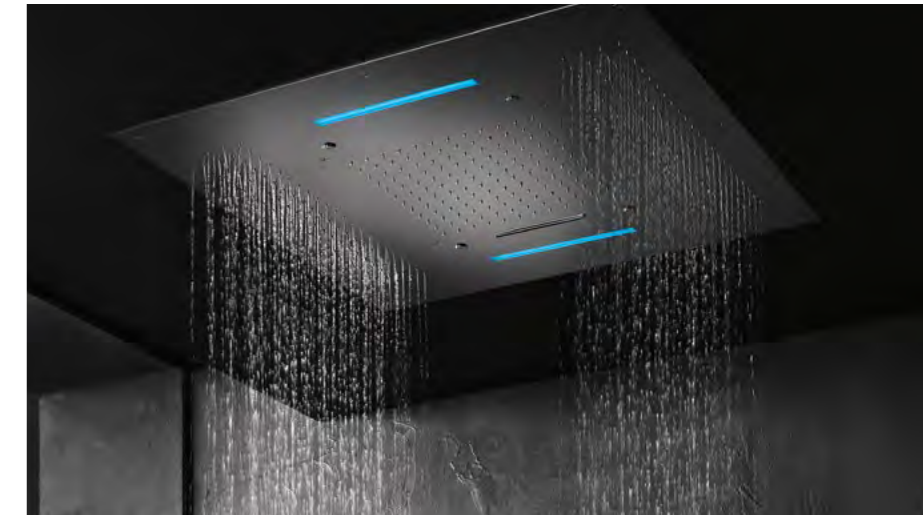

Kit colonne doccia - Chrome



E405002 Colonna doccia completa di soffione Velvet tondo Ø230, doccia Velvet Ø100 e termostatico esterno · Shower column complete with round Velvet Ø230 shower head, Velvet Ø100 hand shower and exposed thermostatic control · Colonne de douche complète avec tête de douche Velvet ronde Ø230, douchette Velvet Ø100 et thermostatique apparent



E405003 Colonna doccia completa di soffione Velvet tondo Ø230mm, doccia Stick Velvet e termostatico esterno · Shower column complete with Velvet round shower head Ø230mm, Stick Velvet hand shower and exposed thermostatic control · Colonne de douche avec tête de douche Velvet ronde Ø230mm, douchette Stick Velvet et thermostatique apparent



E170004 Colonna Fluid L1200mm con presa d'acqua inferiore completa di soffione Emotion Ø250 e doccia Skinny · Fluid shower column L1200mm with bottom water outlet complete with Emotion Ø250 shower head and Skinny hand shower · Colonne de douche Fluid L1200mm avec prise d'eau inférieure complète de tête de douche Emotion Ø250 et douchette Skinny



E170006 Colonna Fluid L1200mm con presa d'acqua esterna completa di soffione Emotion Ø250 e doccia Skinny · Fluid column L1200mm with external water outlet complete with Emotion shower head Ø250 and Skinny hand shower · Colonne Fluid L1200mm avec prise d'eau externe complète de Tête de douche Emotion Ø250 et douchette Skinny

E400000 Termostatico esterno · Exposed thermostatic control · Thermostatique apparent

Finiture | Finishes | Finitions

Almar è tra le prime aziende in Italia, e tra le poche in Europa, a introdurre all'interno dei propri processi produttivi una lavorazione che ha cambiato il concetto di rivestimento: il PVD (Physical Vapor Deposition).

Ottenuto attraverso l'evaporazione dei metalli che compongono lo strato di rivestimento esterno, il PVD migliora le caratteristiche funzionali del prodotto, rendendolo più duraturo e resistente agli agenti atmosferici.

L'intero processo PVD è sicuro ed ecosostenibile: non produce scarti di lavorazione e non utilizza materiali tossici.

Almar is one of the first companies in Italy—and among the few in Europe—to integrate PVD (Physical Vapor Deposition) into its production, a treatment that has redefined the very concept of surface coating. Created by evaporating metals to form a durable, high-performance thin-film, PVD enhances the functional properties of each product, significantly increasing durability and resistance to environmental factors. The entire PVD process is safe and ecologically sustainable: it produces no processing waste and is completely free of toxic materials.

Almar fait partie des premières entreprises en Italie, et parmi les rares en Europe, à avoir introduit dans ses processus de production une technologie qui a transformé le concept de revêtement : le PVD (Physical Vapor Deposition).

Obtenu par l'évaporation des métaux qui composent la couche de revêtement externe, le PVD améliore les caractéristiques fonctionnelles du produit, le rendant plus durable et résistant aux agents atmosphériques.

L'ensemble du processus PVD est sûr et écoresponsable : il ne génère pas de déchets de production et n'utilise pas de matériaux toxiques.



316L

PVD Lucido | PVD polished | PVD Poli



PVD Gold



PVD Deep Black

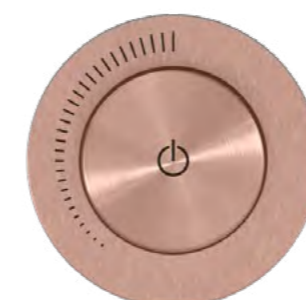

316L
PVD Copper

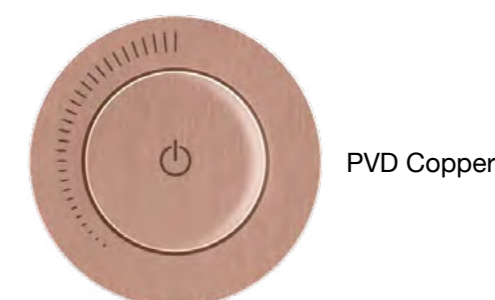

PVD Copper



316L
PVD High Brass

PVD Spazzolato | PVD Brushed | PVD Brossé



PVD High Brass



316L
PVD Gun Metal



PVD Gun Metal



316L
PVD Absolute Black



PVD Absolute Black



Programma docce Velvet

Velvet shower program

Programme douches Velvet

Almar ha cambiato il modo di utilizzare l'acqua nell'ambiente doccia. Il nuovo getto Velvet Rain regala un'esperienza sensoriale avvolgente e silenziosa che sa unire benessere, sostenibilità e stile. Una pioggia fitta, sottilissima e vellutata che avvolge e rilassa il corpo in un tocco sensoriale.

Almar has redefined the shower ritual. Our new Velvet Rain technology offers an enveloping, silent sensory experience that seamlessly blends well-being, style, and sustainability. It delivers a dense, ultra-fine, and velvety flow that cradles your body in a gentle, relaxing caress.

Almar a transformé la manière d'utiliser l'eau dans l'espace douche. Le nouveau jet Velvet Rain offre une expérience sensorielle enveloppante et silencieuse qui associe bien-être, durabilité et style. Une pluie dense, très fine et veloutée qui enveloppe et détend le corps dans un toucher sensoriel délicat.



Doccia Sense *Sense hand shower* *Douchette Sense*

La tecnologia e il design della serie Sense si uniscono per creare un perfetto equilibrio in un semplice gesto quotidiano. Sense è un progetto innovativo sviluppato da Almar per creare un programma docce multifunzione che racchiude, in un unico momento, molteplici esperienze sensoriali nel rispetto dell'ambiente e dei consumi. Grazie a un semplice comando è possibile scegliere tra diverse combinazioni di getti, per funzioni uniche e avvolgenti.

Technology and design in the Sense series join to create a perfect balance within a simple daily ritual. Sense is an innovative concept designed by Almar, a multifunctional shower range that combines diverse sensory experiences into a single moment, respecting the environment and minimising water consumption. A single touch activates a combination of different jets, delivering a unique and truly immersive experience.

La technologie et le design de la série Sense s'unissent pour créer un équilibre parfait dans un geste quotidien simple. Sense est un projet innovant développé par Almar pour créer un programme de douche multifonction qui réunit en un seul moment plusieurs expériences sensorielles dans le respect de l'environnement et des consommations. Grâce à une commande simple, il est possible de choisir entre différentes combinaisons de jets pour des fonctions uniques et enveloppantes.

SENSE ICICLE



SENSE MASSAGE



SENSE ICICLE

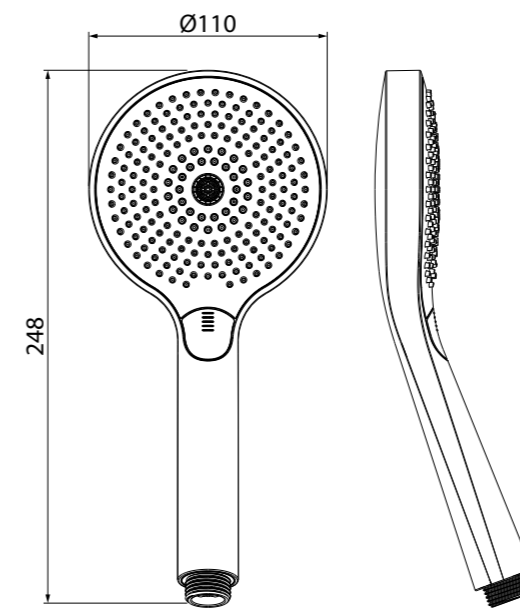

SENSE MASSAGE

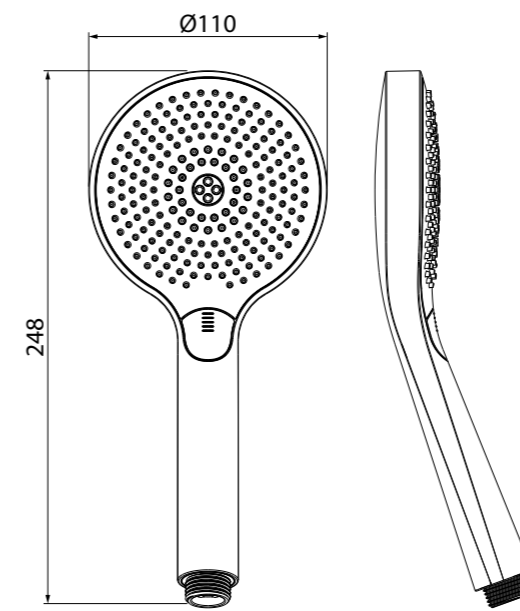

Doccia Stick Velvet

Stick Velvet hand shower

Douchette Stick Velvet

Una doccia dal design intramontabile, minimalista ed essenziale, caratterizzata dal getto Velvet Rain. La disposizione geometrica studiata con numerosi ugelli sottili genera un getto vellutato e silenzioso che avvolge il corpo in modo uniforme e offre una sensazione di comfort unica.

A hand shower with a timeless, minimalist design, featuring the Velvet Rain jet. The meticulously engineered geometric layout of fine nozzles creates a silky, silent flow that uniformly envelops the body, offering a unique sensation of comfort.

Une douchette au design intemporel, minimaliste et essentiel, caractérisée par le jet Velvet Rain. La disposition géométrique étudiée de nombreuses micro-buses génère un jet velouté et silencieux qui enveloppe le corps de manière uniforme et procure une sensation de confort unique.

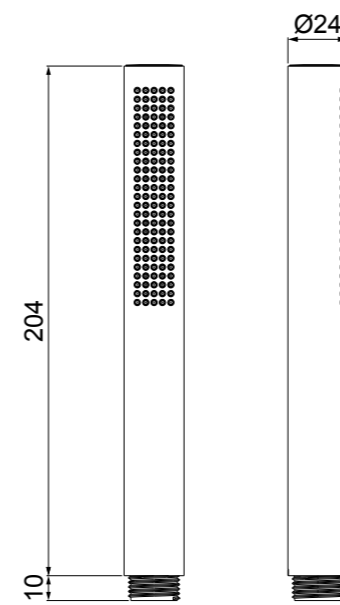

ACCIAIO INOX 316L
316L STAINLESS STEEL
ACIER INOX 316L

OTTONE
BRASS
LAITON

E082126

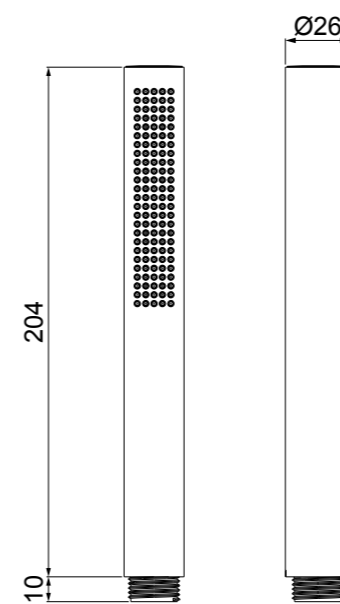

ABS
ABS
ABS

E082130

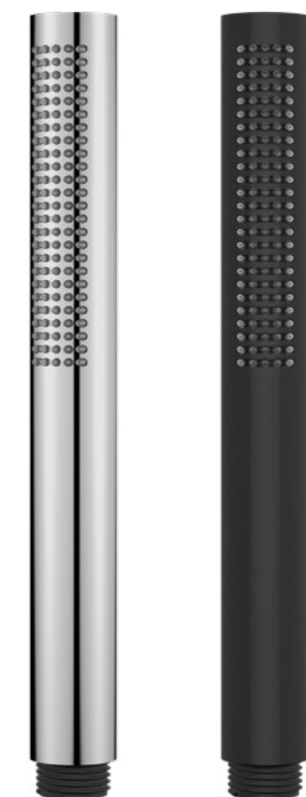

Doccia Velvet

Velvet hand shower

Douchette Velvet

Velvet è una doccia monogetto dal design essenziale e moderno, definita da una geometria che alterna superfici decise e linee più morbide. Il getto Velvet, ampio, pieno e silenzioso, concentra l'esperienza della doccia in un unico flusso, pensato per offrire comfort e semplicità d'uso.

Velvet is a single-jet hand shower with an essential, modern design, defined by a geometry that blends bold surfaces with softer lines. The wide, full, and silent Velvet jet concentrates your shower experience into a single flow, meticulously designed to offer comfort and ease of use.

Velvet est une douchette monojet au design essentiel et moderne, caractérisée par une géométrie qui alterne surfaces plus marquées et lignes plus douces. Caractérisée par le jet Velvet, large, plein et silencieux. Une solution essentielle qui concentre l'expérience de la douche dans un seul jet, conçu pour offrir confort et simplicité d'utilisation.

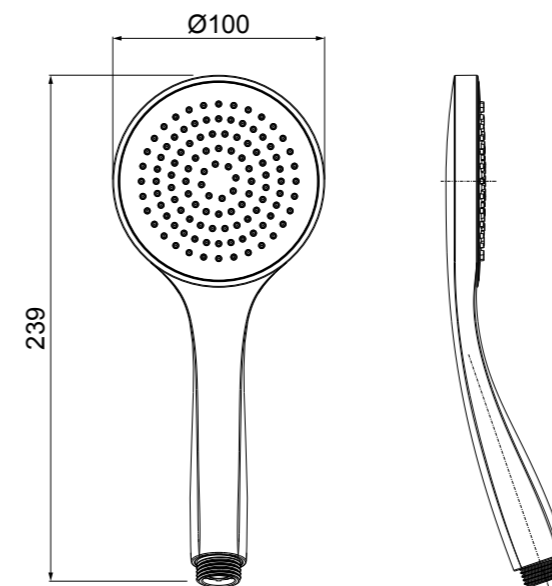

E082114

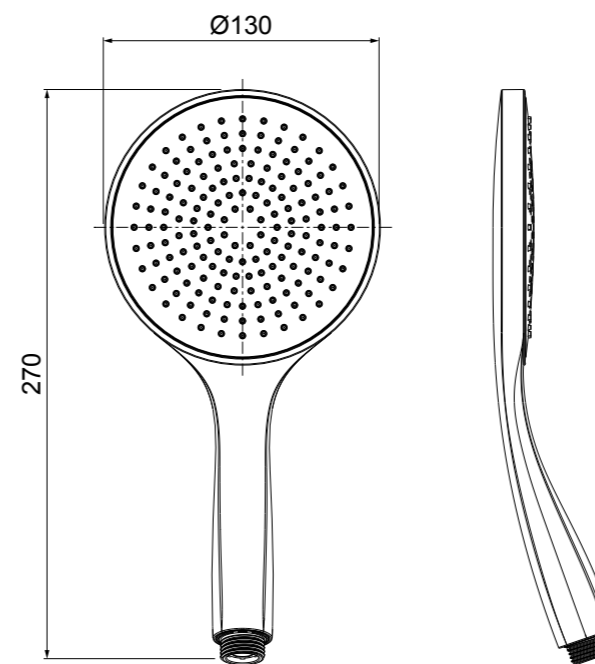

E082116

Soluzioni per il Benessere
Wellness Solutions
Solutions de Bien-Être

GETTI DOCCIA
SHOWER JETS | JET DE DOUCHE

I nostri getti definiscono l'esperienza primaria della doccia e sono studiati per garantire copertura uniforme, continuità di flusso e controllo dell'erogazione.

Ogni modalità interpreta l'acqua in modo diverso, combinando intensità, distribuzione e movimento per adattarsi a ritmi, esigenze e momenti differenti della giornata.

Our jets define the primary shower experience and are designed to ensure uniform coverage, continuous flow and precise water control.

Each spray mode interprets water in a different way, combining intensity, distribution and movement to adapt to different rhythms, needs and moments of the day.

Nos jets définissent l'expérience principale de la douche et sont conçus pour garantir une couverture uniforme, une continuité de flux et un contrôle précis de l'eau.

Chaque mode de jet interprète l'eau de manière différente, en combinant intensité, répartition et mouvement pour s'adapter aux rythmes, aux besoins et aux différents moments.



 **VELVET**

Una pioggia sottile, uniforme e avvolgente, che rigenera il corpo delicatamente.

A fine, even and enveloping rain that gently revitalises the body.

Une pluie fine, uniforme et enveloppante qui régénère délicatement le corps.



 **INTENSE RAIN**

Corposi flussi d'acqua avvolgono il corpo con un getto intenso e dal forte potere rigenerante.

Full-bodied water flows envelop the body with an intense jet and a strong regenerative effect.

Des flux d'eau denses enveloppent le corps avec un jet intense et au fort pouvoir régénérant.



 **RAIN**

Un getto uniforme e costante, pensato per accompagnare la doccia quotidiana con efficacia e naturalezza. Rapido e versatile, si adatta con equilibrio a ogni momento della giornata.

A uniform and steady spray, designed to accompany the daily shower with efficiency and natural ease. Quick and versatile, it adapts with balance to every moment of the day.

Un jet uniforme et constant, conçu pour accompagner la douche quotidienne avec efficacité et naturel. Rapide et polyvalent, il s'adapte avec équilibre à chaque moment de la journée.



 **CASCATA**

Un'ampia e morbida cascata d'acqua si riversa sul corpo con un getto corposo e continuo, generando un effetto esteso e distensivo.

A wide and soft waterfall of water flows over the body with a full-bodied, continuous jet, creating an extended and relaxing effect.

Une large et douce cascade d'eau se déverse sur le corps avec un jet dense et continu, générant un effet étendu et délassant.

 **ICICLE**

Un elegante cilindro d'acqua raggiunge il corpo con un getto pieno e definito, per poi scorrere sulla pelle in modo delicato e uniforme.

An elegant cylinder of water reaches the body with a full and defined jet, then flows over the skin in a gentle and uniform way.

Un élégant cylindre d'eau atteint le corps avec un jet plein et défini, puis s'écoule sur la peau de manière douce et uniforme.



 **WIRE**

Intensi cilindri d'acqua generano un'ampia cascata a pettine, distribuendosi con uniformità sul corpo e mantenendo costante la loro consistenza.

Intense cylinders of water create a wide comb-like cascade, distributing evenly over the body while maintaining a constant consistency.

D'intenses cylindres d'eau créent une large cascade en peigne, se répartissant uniformément sur le corps tout en conservant une consistance constante.



 **SPIN**

Un moto a spirale preciso e continuo genera un getto intenso e dinamico, che agisce in modo mirato sul corpo con un'azione decisa e strutturata.

A precise and continuous spiral motion generates an intense and dynamic spray, acting in a targeted way on the body with a firm and structured action.

Un mouvement en spirale précis et continu génère un jet intense et dynamique, agissant de manière ciblée sur le corps avec une action nette et structurée.



 **MIST**

Un getto nebulizzato rigenerante che avvolge la pelle con un tocco impalpabile, silenzioso e leggero.

A revitalizing mist spray that envelops the skin in a silent, light and delicate touch.

Un jet brumisé régénérant qui enveloppe la peau d'un toucher impalpable, silencieux et léger.



GETTI LATERALI

BODY JETS | JETS LATÉRAUX

I getti massaggianti ampliano l'esperienza della doccia attraverso diverse modalità di erogazione, progettate per offrire benefici mirati e sensazioni complementari.

Ogni getto interpreta l'acqua in modo specifico, combinando intensità, movimento e delicatezza per un benessere personalizzabile.

Body jets enhance the shower experience through different water delivery modes, designed to provide targeted benefits and complementary sensations.

Each jet interprets water in a distinct way, combining intensity, movement and softness for a customizable sense of well-being.

Les jets massants enrichissent l'expérience de la douche grâce à différentes modalités de diffusion de l'eau, conçues pour offrir des bienfaits ciblés et des sensations complémentaires.

Chaque jet interprète l'eau de manière spécifique, en associant intensité, mouvement et douceur pour un bien-être personnalisable.



SPIN

Il getto rotativo Spin sprigiona un massaggio intenso e localizzato su gambe e schiena, stimolando la circolazione e donando una profonda sensazione di tonicità.

The wall-mounted Spin rotating jet provides an intense, targeted massage for legs and back, stimulating blood circulation and enhancing tissue tone.

Installé au mur, le jet rotatif Spin diffuse un massage intense et ciblé sur les jambes et le dos, stimulant la circulation sanguine et renforçant la tonicité des tissus.



WAVE

Un'onda basculante che avvolge con intensità, offrendo un massaggio total body profondo e rigenerante.

A rocking wave that envelops with intensity, providing a deep and revitalizing full-body massage.

Une onde oscillante qui enveloppe avec intensité, offrant un massage profond et régénérant du corps entier.



SPRAY

Un ampio getto a pioggia, soffice e avvolgente, per un'esperienza delicata e armoniosa.

A wide rain spray, gentle and enveloping, for a delicate and harmonious experience.

Un large jet pluie, souple et enveloppant, pour une expérience délicate et harmonieuse.



MIST

Un getto nebulizzato rigenerante che avvolge la pelle con un tocco impalpabile, silenzioso e leggero.

A revitalizing mist spray that envelops the skin in a silent, light and delicate touch.

Un jet brumisé régénérant qui enveloppe la peau d'un toucher impalpable, silencieux et léger.



Controllo dell'Acqua
Water Control
Gestion de l'Eau

I sistemi di controllo dell'acqua nascono per gestire l'esperienza della doccia in ogni sua configurazione, mettendo in relazione soffioni, getti e comandi in un unico linguaggio progettuale.

Soluzioni sviluppate per garantire precisione, continuità di flusso e libertà compositiva, capaci di adattarsi a diverse esigenze funzionali ed estetiche.

Dalla modularità dei sistemi a incasso alla versatilità dei corpi universali, fino alle soluzioni ad alta portata, ogni progetto interpreta la gestione dell'acqua come equilibrio tra tecnologia, design e prestazione.

Water control systems are designed to manage the shower experience in every configuration, connecting shower heads, jets and controls within unified design projects.

Solutions developed to ensure precision, continuous flow and compositional freedom, capable of adapting to different functional and aesthetic requirements.

From the modularity of built-in systems to the versatility of universal bodies, up to high-flow solutions, each project interprets water management as a balance between technology, design and performance.

Les systèmes de contrôle de l'eau sont conçus pour gérer l'expérience de la douche dans chacune de ses configurations, en mettant en relation têtes de douche, jets et commandes dans un langage de conception unifié.

Des solutions développées pour garantir précision, continuité de flux et liberté de composition, capables de s'adapter à différentes exigences fonctionnelles et esthétiques.

De la modularité des systèmes encastrés à la polyvalence des corps universels, jusqu'aux solutions à haut débit, chaque projet interprète la gestion de l'eau comme un équilibre entre technologie, design et performance.



Modular

Modular è il sistema di moduli a incasso brevettato da Almar, progettato per offrire la massima libertà compositiva e funzionale nella configurazione della doccia e della vasca. Una piattaforma flessibile, pensata per sistemi da una a cinque funzioni, disponibile in tre versioni distinte: Termostatico Push, Termostatico e Meccanico, per rispondere a differenti esigenze di controllo dell'acqua. Grazie a uno studio avanzato delle cartucce e alla razionalizzazione degli ingombri, il sistema Modular consente di ridurre lo spazio di installazione e di realizzare sistemi multifunzione, mantenendo proporzioni armoniche. Disponibile con estetiche tonde e quadre e in tutte le finiture Almar, si adatta con coerenza a progetti di diversa scala e linguaggio formale.

Modular is a built-in system patented by Almar, designed to offer maximum compositional and functional freedom in the configuration of showers and bathtubs. A flexible platform, conceived for systems ranging from one to five functions, available in three distinct versions: Push Thermostatic, Thermostatic and Mechanical, to meet different water control requirements. Thanks to advanced cartridge engineering and the rationalization of overall dimensions, the Modular system requires less space for installation and allows the creation of multifunction systems, maintaining harmonious proportions. Available in round and square designs and in all Almar finishes, it adapts coherently to projects of different scales and formal languages.

Modular est un système breveté par Almar, conçu pour offrir une liberté de composition et de fonctionnalité maximale dans la configuration de la douche et de la baignoire. Une plateforme flexible, pensée pour des systèmes de une à cinq fonctions, disponible en trois versions distinctes: Thermostatique Push, Thermostatique et Mécanique, afin de répondre à différentes exigences de contrôle de l'eau. Grâce à une étude avancée des cartouches et à la rationalisation des encombrements, le système Modular permet de réduire l'espace d'installation et de réaliser des systèmes multifonctionnels, tout en conservant des proportions harmonieuses. Disponible en esthétiques rondes et carrées et dans toutes les finitions Almar, il s'adapte avec cohérence à des projets de différentes échelles et de différents langages formels.

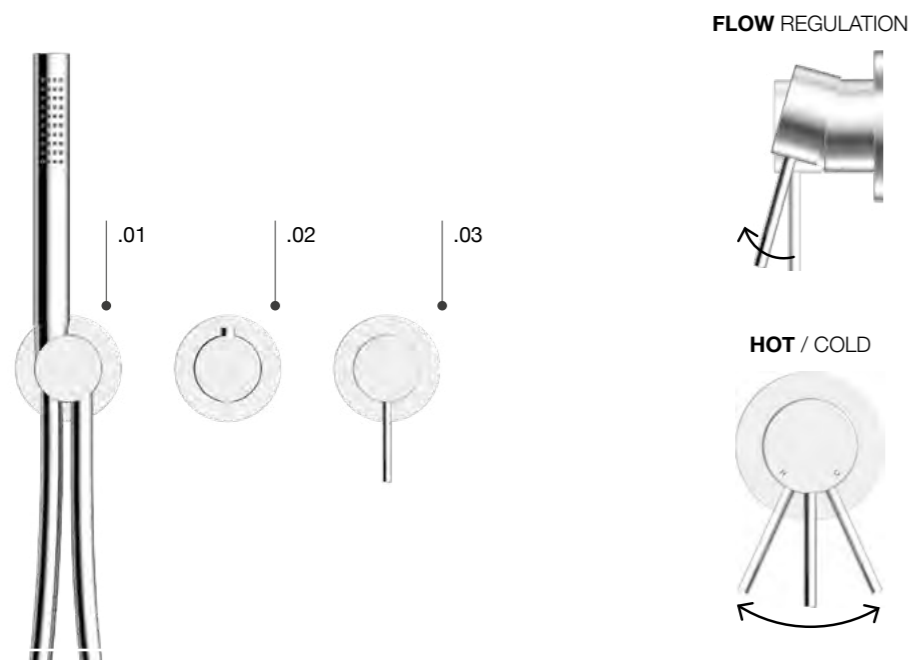

meccanica
mechanical / mécanique

- 01. presa acqua con doccia
water outlet with hand shower
sortie d'eau avec douchette
- 02. deviatore
diverter
inverseur
- 03. apertura/chiusura + regolazione temperatura
on/off control + temperature adjustment
ouverture/fermeture + réglage de la température

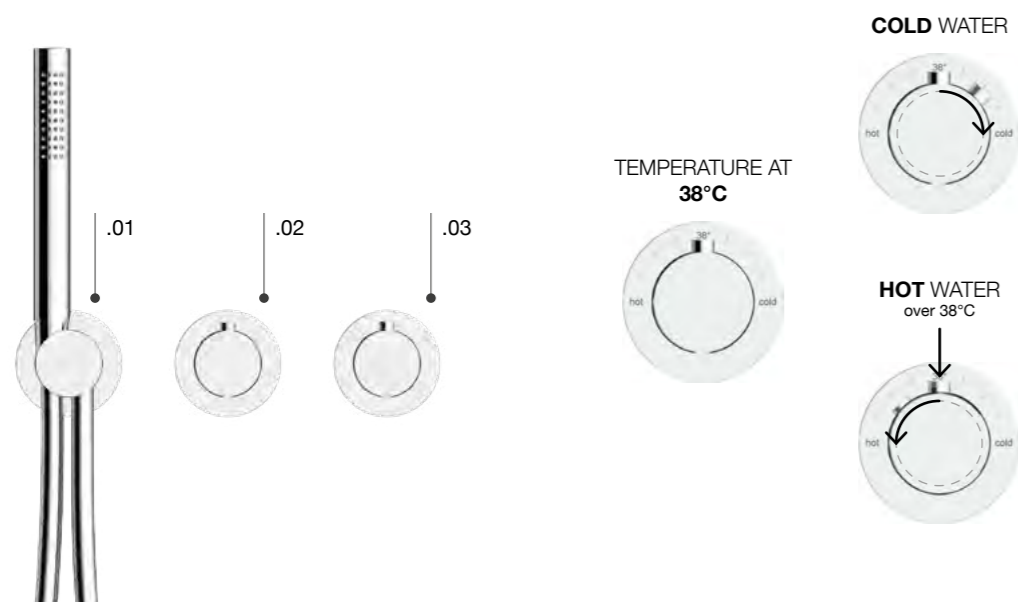

termostatica
thermostatic / thermostatique

- 01. presa acqua con doccia
water outlet with hand shower
sortie d'eau avec douchette
- 02. apertura/chiusura + deviatore
on/off control + diverter
ouverture/fermeture + inverseur
- 03. regolazione temperatura
temperature adjustment
réglage de la température

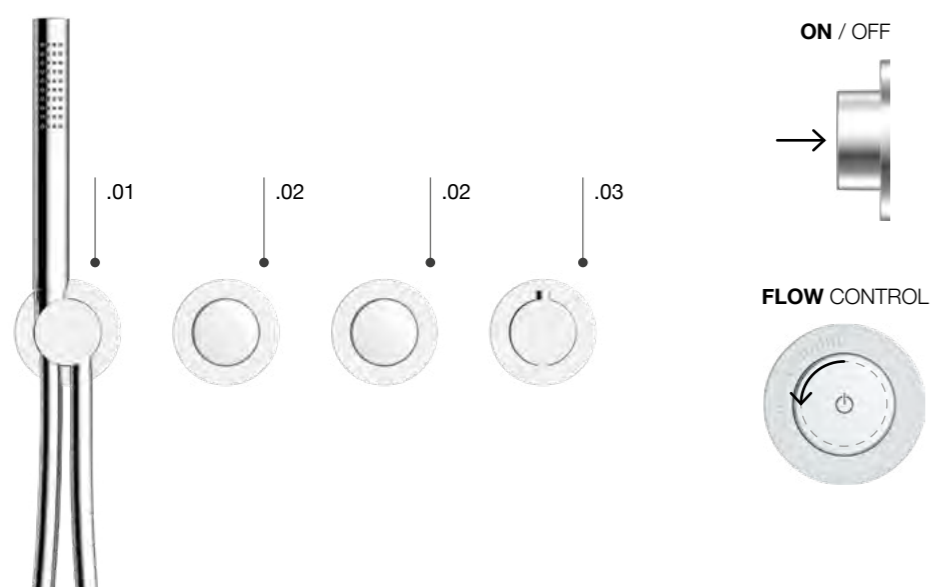
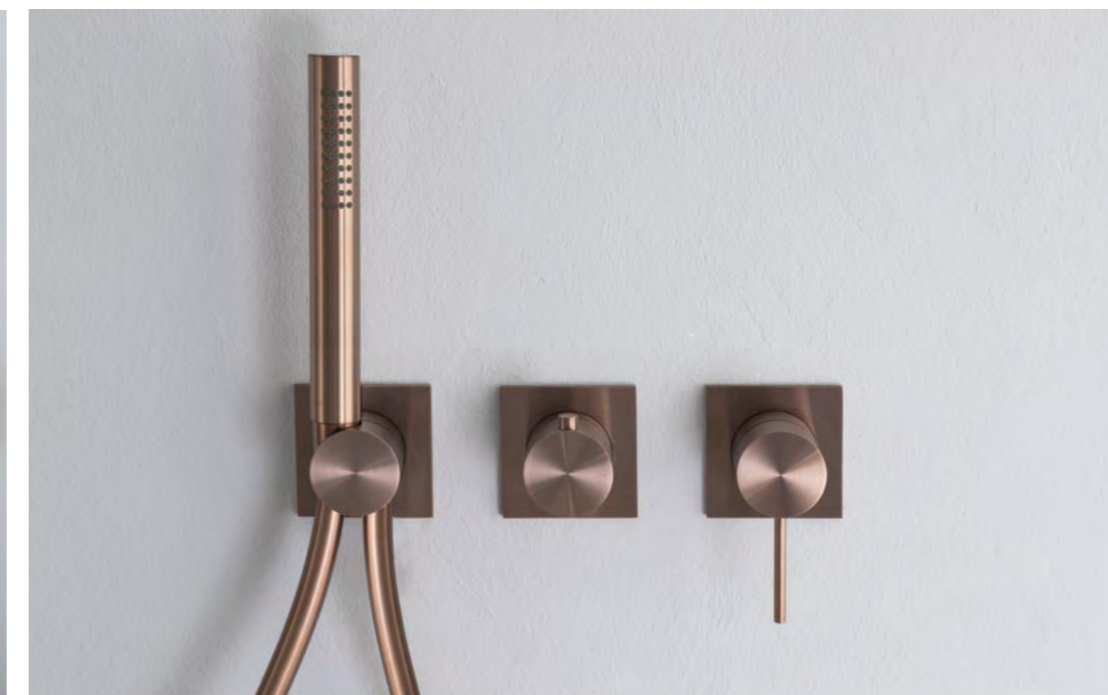

termostatica push
push thermostatic / thermostatique push

- 01. presa acqua con doccia
water outlet with hand shower
sortie d'eau avec douchette
- 02. apertura/chiusura + regolazione portata
on/off control + flow rate adjustment
ouverture/fermeture + réglage du débit
- 03. regolazione temperatura
temperature adjustment
réglage de la température





Core

Core è il sistema di controllo dell'acqua basato su un corpo a incasso universale, progettato per offrire versatilità progettuale e libertà di personalizzazione nella configurazione della doccia. Una soluzione pensata per sistemi da una a tre funzioni. Disponibile in tre versioni funzionali: Termostatico Push, Termostatico e Meccanico, per rispondere a differenti modalità di utilizzo e controllo. Disponibile in estetiche tonde e quadre e in tutte le finiture Almar, Core unisce razionalità tecnica e coerenza formale, mantenendo equilibrio tra prestazione, design e semplicità d'installazione.

Core is a water control system based on a universal built-in body, designed to offer design versatility and freedom of customization in shower configurations. A solution conceived for systems with one to three functions. Available in three functional versions: Push Thermostatic, Thermostatic and Mechanical, to meet different modes of use and control. Available in round and square designs and in all Almar finishes, Core combines technical rationality with formal coherence, maintaining a balance between performance, design and ease of installation.

Core est le système de contrôle de l'eau basé sur un corps encastré universel, conçu pour offrir une grande polyvalence de conception et une liberté de personnalisation dans la configuration de la douche. Une solution pensée pour des systèmes de une à trois fonctions. Disponible en trois versions fonctionnelles : Thermostatique Push, Thermostatique et Mécanique, afin de répondre à différentes modalités d'utilisation et de contrôle. Disponible en esthétiques rondes et carrées et dans toutes les finitions Almar, Core associe rationalité technique et cohérence formelle, en maintenant un équilibre entre performance, design et simplicité d'installation.

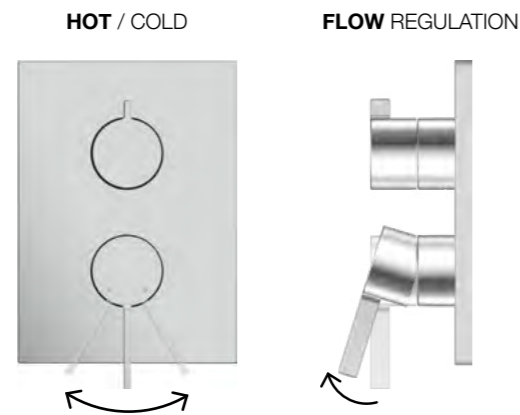
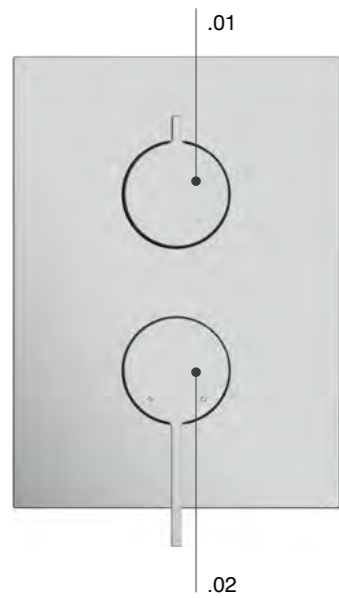

meccanico
mechanical | mécanique

- 01. deviatore
diverter
inverseur
- 02. apertura/chiusura + regolazione temperatura
on/off control + temperature adjustment
ouverture/fermeture + réglage de la température

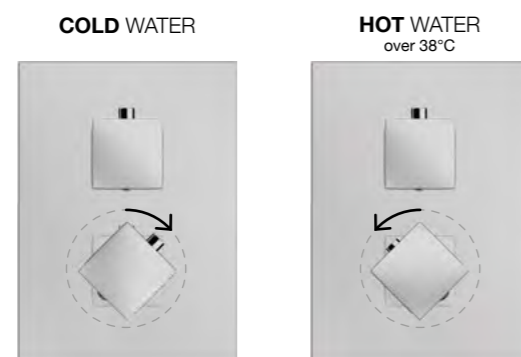
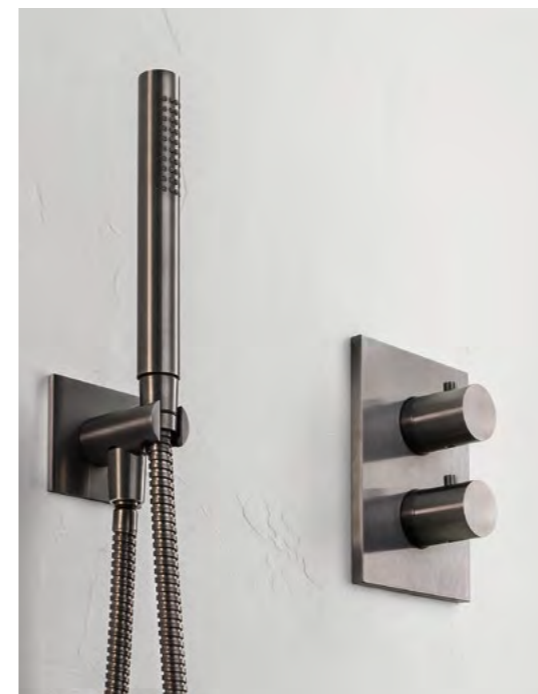

termostatica
thermostatic | thermostatique

- 01. apertura/chiusura + deviatore
on/off control + diverter
ouverture/fermeture + inverseur
- 02. regolazione temperatura
temperature adjustment
réglage de la température



termostatica push
push thermostatic | thermostatique push

- 01. apertura/chiusura + regolazione portata
on/off control + flow rate adjustment
ouverture/fermeture + réglage du débit
- 02. regolazione temperatura
temperature adjustment
réglage de la température

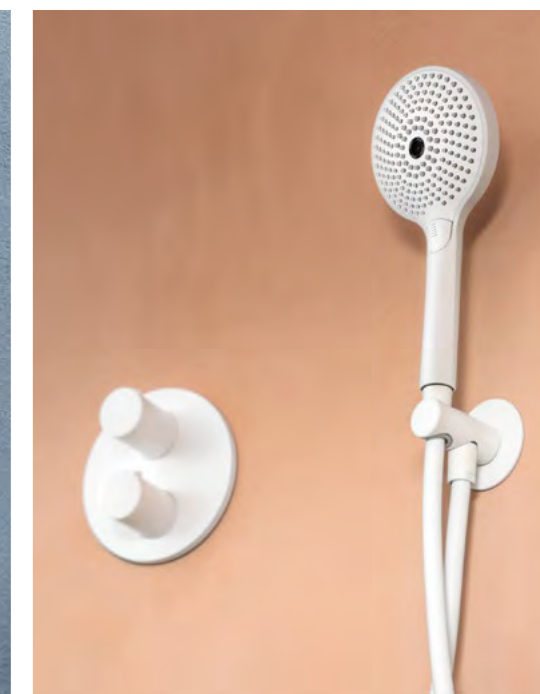



High Flow

High Flow è un sistema termostatico ad alta portata progettato per il controllo di configurazioni doccia articolate e sistemi multifunzione. Una soluzione sviluppata per gestire elevati volumi d'acqua, assicurando stabilità della temperatura, continuità di flusso e prestazioni costanti anche con più funzioni attive contemporaneamente. Pensato per sistemi da una a sei funzioni, High Flow consente l'utilizzo simultaneo di diverse uscite, come soffioni, cascate, docce o body jet. Disponibile in estetiche tonde e quadre e in tutte le finiture Almar, interpreta il controllo dell'acqua come sintesi tra tecnologia, potenza e precisione progettuale.

High Flow is a high-flow thermostatic system designed to control articulated shower configurations and multifunction systems. A solution developed to manage high volumes of water, ensuring temperature stability, flow continuity and consistent performance even with multiple functions active simultaneously. Designed for systems with one to six functions, High Flow allows the simultaneous use of different outlets, such as shower heads, waterfalls, hand showers or body jets. Available in round and square designs and in all Almar finishes, it interprets water control as a synthesis of technology, power and design precision.

High Flow est un système thermostatique à haut débit conçu pour le contrôle de configurations de douche articulées et de systèmes multifonctions. Une solution développée pour gérer des volumes d'eau élevés, en garantissant la stabilité de la température, la continuité du flux et des performances constantes même avec plusieurs fonctions actives simultanément. Pensé pour des systèmes de une à six fonctions, High Flow permet l'utilisation simultanée de différentes sorties, telles que têtes de douche, cascades, douchettes ou body jets. Disponible en esthétiques rondes et carrées et dans toutes les finitions Almar, il interprète le contrôle de l'eau comme une synthèse entre technologie, puissance et précision conceptuelle.

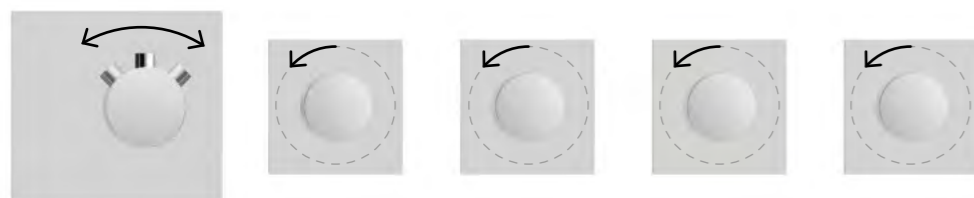
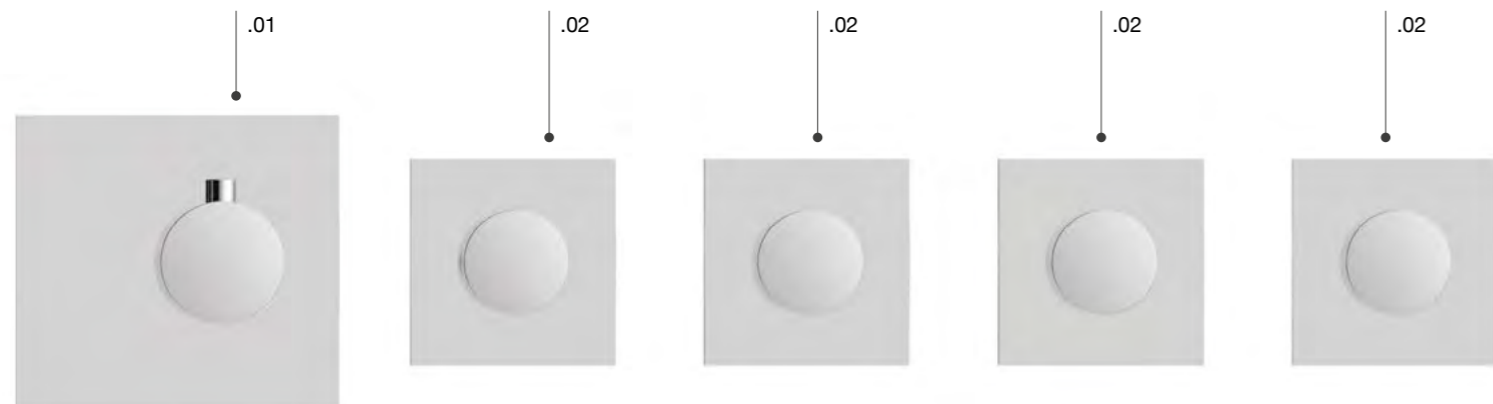

termostatico high flow
thermostatic high flow
thermostatique high flow

01. regolazione temperatura
 temperature adjustment
 réglage de la température

02. apertura/chiusura
 on/off control
 ouverture/fermeture

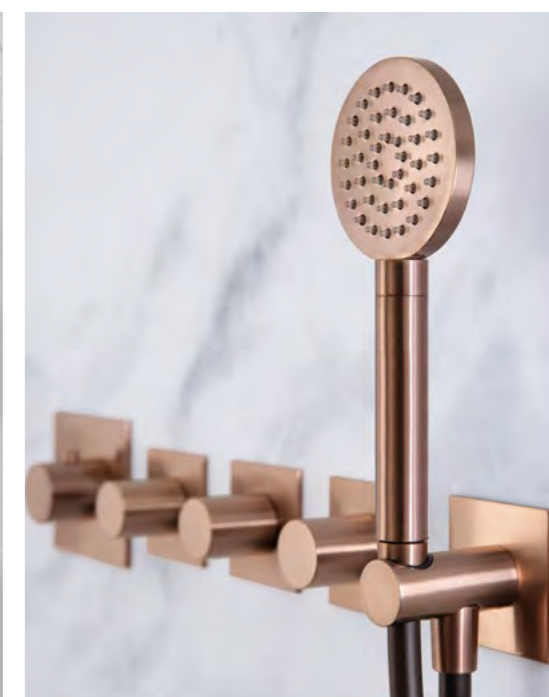
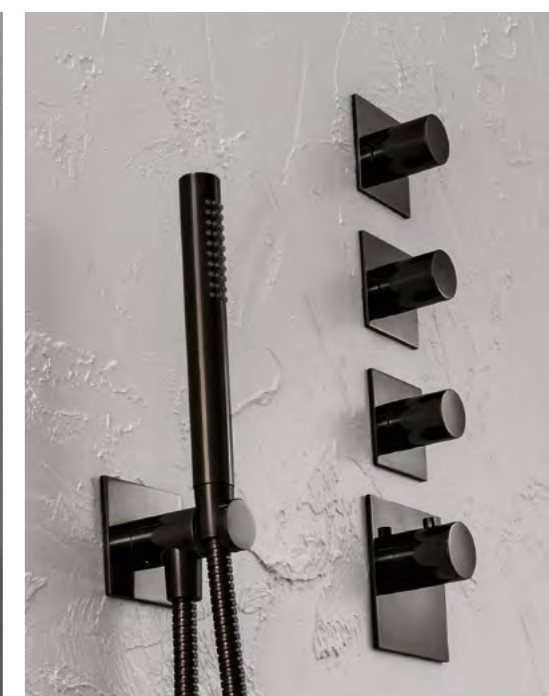
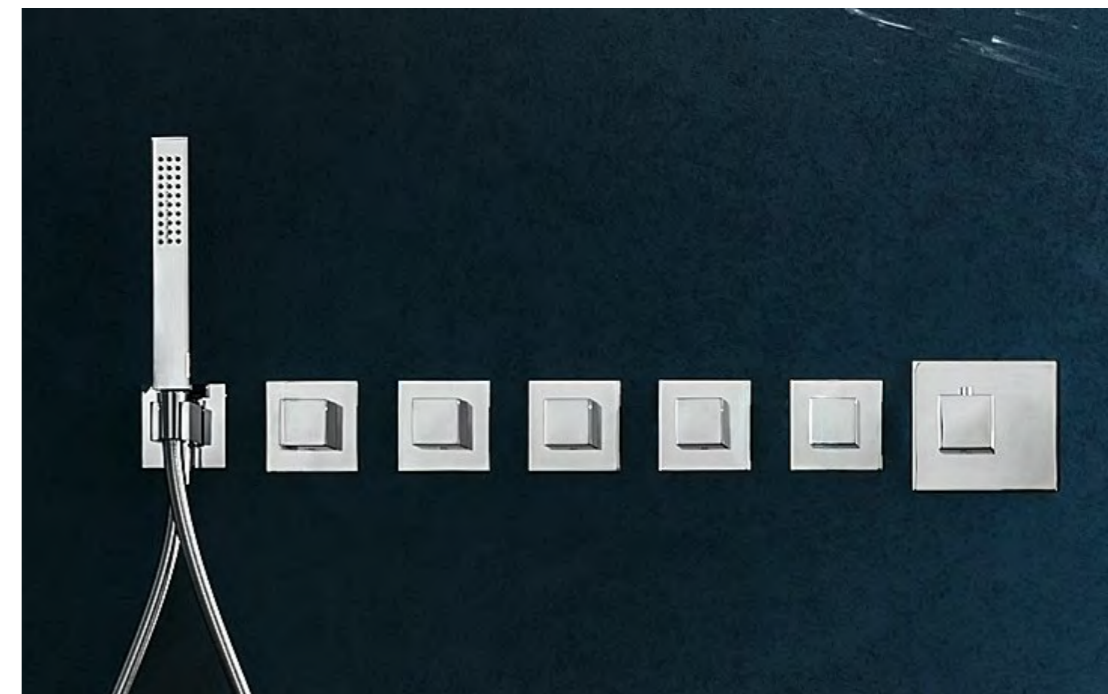

Almar S.r.l.

Via dello Sport, 17 bis

21026 Gavirate (VA) Italy

Tel +39 0332 743961

Fax +39 0332 743886

www.almarmadeinitaly.it

Almar si riserva il diritto di apportare modifiche a prodotti e componenti, qualora lo ritenga necessario, senza preavviso e in qualunque momento.

Almar reserves the right to modify products and components, whenever necessary, without notice at any time.

Almar se réserve le droit de modifier ses produits et ses accessoires, si nécessaire, à tout moment sans préavis.

Almar behält sich das Recht vor, jederzeit ohne vorherige Ankündigung, die Produkten und Zubehörteile ändern, wenn es notwendig ist.

Almar se reserva el derecho a modificar los productos y accesorios, cuando es necesario, en cualquier momento sin previo aviso.

Questo catalogo è tutelato dalla legge sui diritti d'autore (legge 22/4/1941 n°633) e dalla legge 14/12/1942 n.1485. E' vietata ogni riproduzione anche parziale dello stesso.

This catalogue is copyrighted and protected by the Italian law (22/4/1941 n°633 and 14/12/1942 n°1485). It is strictly forbidden to copy any part of it.

Ce catalogue est défendu de la loi sur les droites d'auteur (loi 22/4/1941 n° 633) et de la loi 14/12/1942 n° 1485. Il est interdit chaque reproduction, même partielle.

Dieses Katalog ist vom Urheberrechtsgesetz (Gesetz 22/4/1941 n. 633) und vom Gesetz 14/12/1942 n. 1485 geschützt. Jeder Nachdruck auch teilweise ist verboten.

Este catalogo esta protegido por la Ley de los Derechos de Autor (Ley 22/4/1941 n°633) y de la Ley 14/12/1942 n° 1485. Esta prohibida la reproducción, incluso parcial, del mismo.

Concept: Almar

Photograph: InVarianti - Real Time - Pierluigi Fossa

Print: Formaprinting