

Product Type: **Thermostat Modular**  
 Product Code: **E180186**  
 Product Name: **Estetiche per versione termostatica 2 vie**  
**2 way trim set for thermostat version**

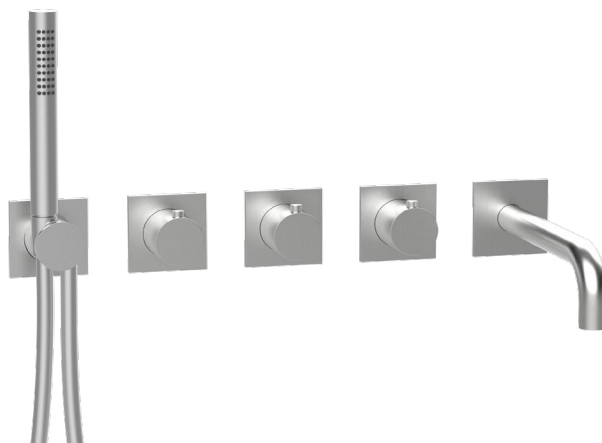

Description: estetica termostatica bordo vasca rosoni quadri e maniglie tonde 2 vie con doccia  
*2 way thermostat square rosettes and round handles trim set with hand shower for bathtub*







Dimensions: rosoni | rosettes 70x70 mm  
 Material: Acciaio 316 | 316 Stainless Steel

Notes: da abbinare con: **E169000** incasso termostatico 2 vie flessibile\* con attacco speciale, non possono essere installati flessibili con attacco standard  
 le estetiche possono essere installate su entrambi i moduli incasso verticale e orizzontale

*to combine with: **E169000** 2-way thermostat concealed module flexible hose\* with special connection, hoses with standard connection cannot be installed the trim set can be installed on both vertical and horizontal concealed modules*

Functions:  thermostat  2 Way

Finishes: **Stainless Steel**  **316 AISI** | **316 PVD Brushed**  **316 HB**  **316 CO**  **316 GM**  **316 AB**  
 High Brass | Copper | Gun Metal | Absolute Black

## DIMENSIONS

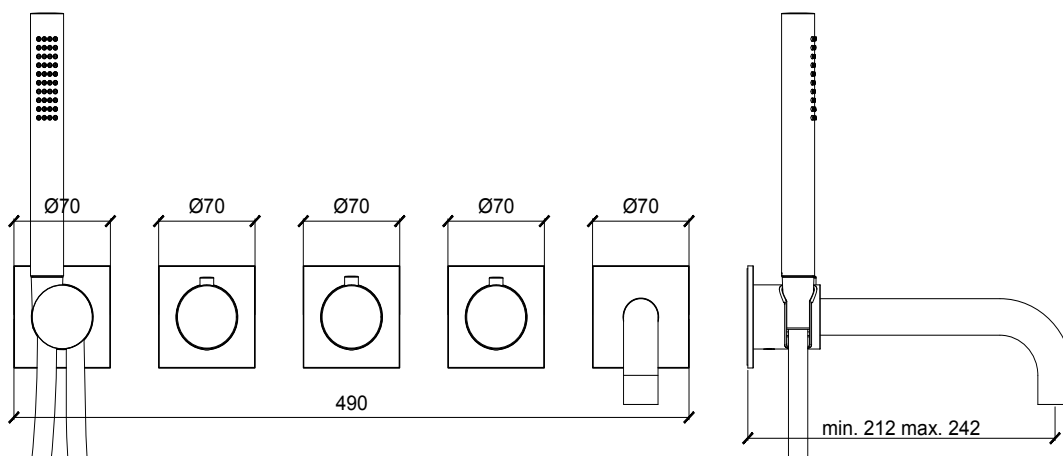

## CURA DEL PRODOTTO

Per evitare danni al vostro bagno o all'apparecchiatura acquistata vi invitiamo ad osservare le seguenti raccomandazioni di utilizzo:

- Spurgare l'impianto prima di collegare l'apparecchio.
- Pulire periodicamente la fessura di erogazione acqua da eventuali depositi di calcare che potrebbero compromettere il corretto funzionamento.

**Consiglio:** L'installazione di un impianto di filtraggio e addolcitura delle acque migliora e prolunga la vita dei nostri apparecchi e dell'impianto stesso.

### PULIZIA PARTI METALLICHE:

Per la semplice pulizia delle parti metalliche del prodotto è sufficiente usare un panno morbido e inumidito con acqua e sapone o un prodotto anticalcare.

Per evitare la formazione di macchie, dovute alla presenza di calcio nell'acqua, si consiglia di asciugare con un panno dopo ogni uso.

Consiglio: Si prega di usare solo detergenti naturali a base di sapone evitando quelli contenenti alcool, acido cloridrico o acido fosforico, candeggina, cloro, ecc., e quelli contenenti polveri abrasive.

## PRODUCT CARE

*To avoid damages to the purchased equipment, please observe the following recommendations for use:*

- *Clean the plumbing before connecting the device.*
- *Periodically clean the water blade to avoid any limestone deposits that could compromise the good functioning.*

**Advice:** *The installation of a filter and water-softener system improves and extends the life of the devices and of the plant itself.*

### CLEANING OF METAL PARTS:

*For an easy cleaning of the metal parts of the product, simply use a soft cloth moistened in water and soap or an anti-limestone detergent.*

*To avoid spots caused by calcium in water, we advise drying with a cloth after each use.*

**Advice:** *Please use only natural soap-based detergents avoiding those with alcohol, hydrochloric acid or phosphoric acid, bleach, chlorine etc. and those containing abrasive powders.*

## PACKING



1

## PRODOTTI CORRELATI | RELATED PRODUCTS



### E169000

incasso termostatico 2 vie

2-way thermostat concealed module